

# Panasonic®

## Operating Instructions

---

2.4 GHz Digital Cordless Answering System

Model No. **KX-TG2388**

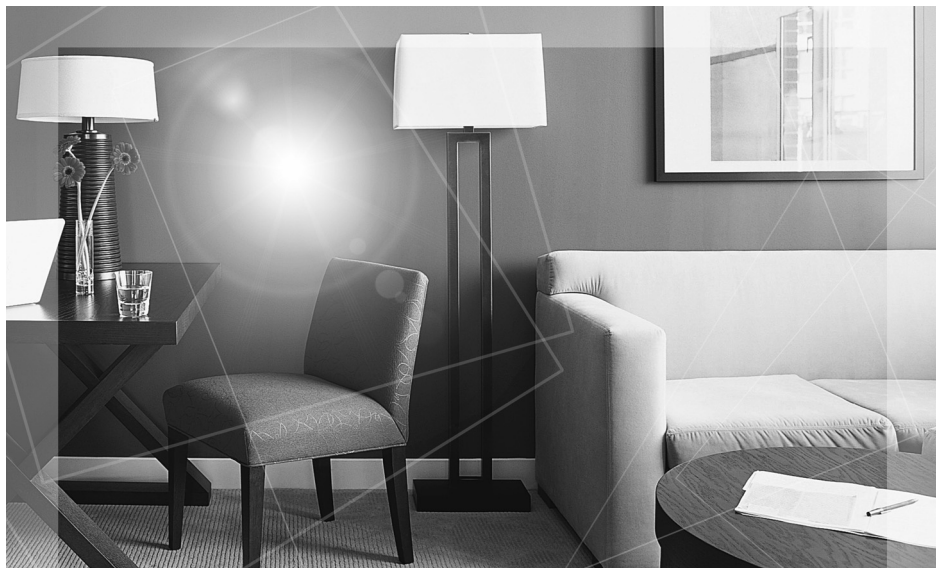

This unit is compatible with Caller ID. To use this feature, you must subscribe to the appropriate service offered by your service provider.

**Charge the battery for 6 hours before initial use.**

Please read these Operating Instructions before using the unit and save for future reference.

For assistance, visit our website: <http://www.panasonic.com> for customers in the U.S.A. or Puerto Rico.

# Table of Contents

## Introduction

Accessory information . . . . .	4
Important safety instructions . . . . .	5
For best performance . . . . .	7

## Preparation

Connections . . . . .	8
Battery installation . . . . .	9
Battery charge . . . . .	9
Battery replacement . . . . .	11
About the bone conduction earpiece . . . . .	11
Controls and displays . . . . .	12
Controls . . . . .	12
Display . . . . .	14
Setting the unit before use . . . . .	14
Handset display language . . . . .	14
Setting the dialing mode . . . . .	15
Setting the date and time . . . . .	15

## Making/Answering Calls

Making calls . . . . .	16
Using the handset . . . . .	16
Using the base unit . . . . .	18
Answering calls . . . . .	20
Using the handset . . . . .	20
Using the base unit . . . . .	20
Useful features during a call . . . . .	20
MUTE button . . . . .	20
FLASH button . . . . .	21
For Call Waiting service users . . . . .	21
Temporary tone dialing (for rotary/pulse service users) . . . . .	21

## Phonebook

Using the phonebook . . . . .	22
Adding items to the phonebook using the handset . . . . .	22
Calling someone in the phonebook . . . . .	23
Name Announcement . . . . .	23
Chain dial feature using the handset . . . . .	24
Editing items in the phonebook . . . . .	24
Erasing items in the phonebook . . . . .	24

## One-Touch Dialer

Storing an item in the phonebook to the one-touch dialer using the handset . . . . .	25
Dialing a stored number using the handset . . . . .	25
Erasing items using the handset . . . . .	26

## Caller ID Service

Using Caller ID service . . . . .	27
Talking Caller ID . . . . .	27
Caller list . . . . .	28
Viewing the caller list using the handset . . . . .	28
Editing a caller's phone number before calling back using the handset . . . . .	30
Storing caller information into the phonebook using the handset . . . . .	31
Erasing caller information using the handset . . . . .	31

## Locator/Intercom

Locator/Intercom . . . . .	32
Making intercom calls . . . . .	32
Answering intercom calls . . . . .	32
Transferring a call . . . . .	33
Quick call transfer . . . . .	33
Conference calls . . . . .	34
Call share . . . . .	34

## Programmable Settings

Guide to handset programming . . . . .	35
Programming via direct commands . . . . .	36
Direct commands chart . . . . .	37
Ringer settings . . . . .	39
Handset ringer volume . . . . .	39
Base unit ringer volume . . . . .	39
Handset ringer tone . . . . .	39
Base unit ringer tone . . . . .	40
Handset incoming call tone . . . . .	40
Base unit incoming call tone . . . . .	40
Display setting . . . . .	41
Handset LCD contrast . . . . .	41
Functions . . . . .	41
Handset Talking Caller ID . . . . .	41
Base unit Talking Caller ID . . . . .	41
Initial setting . . . . .	42
Caller ID edit . . . . .	42
Handset key tone . . . . .	42
Auto talk . . . . .	43
Flash time . . . . .	43
Line mode . . . . .	43
Accessibility . . . . .	44
Talking Keypad . . . . .	44
Handset Name Announcement . . . . .	44
Handset Telecoil Hearing Aid Mode . . . . .	44
Re-registering the handset . . . . .	45

## **Answering System**

### **Features**

Answering system . . . . .	46
Recording your greeting message . . . .	46
Erasing your greeting message . . .	47
Pre-recorded greeting message . . .	47
Turning the answering system on/off . .	47
Using the base unit . . . . .	47
Using the handset . . . . .	47
Screening your calls . . . . .	48
Listening to messages . . . . .	48
Listening to messages using the base unit . . . . .	48
Listening to messages using the handset (Remote Operation) . . . . .	49
Recording a memo message . . . . .	51
Memory capacity . . . . .	52
Remote operation . . . . .	52
Using the answering system remotely . . . . .	52
Answering system settings . . . . .	54
Remote code . . . . .	54
Caller's recording time . . . . .	54
Number of rings . . . . .	54
Recording mode . . . . .	55
Message alert . . . . .	55

### **Useful Information**

Wall mounting . . . . .	56
Charger unit . . . . .	58
Belt clip . . . . .	58
Shoulder Rest Attachment . . . . .	59
Headset (optional) . . . . .	59
If the Following Appear on Your	
Display . . . . .	60
Troubleshooting . . . . .	61
Answering System . . . . .	65
General . . . . .	66
FCC and other information . . . . .	67
Specifications . . . . .	70
Base unit . . . . .	70
Handset . . . . .	70
Charger unit . . . . .	70
Warranty . . . . .	71
Customer services . . . . .	73
Index . . . . .	74

## Introduction

### Thank you for purchasing a Panasonic cordless telephone.

We recommend keeping a record of the following information for future reference.

Serial No. \_\_\_\_\_

Date of purchase \_\_\_\_\_

(found on the bottom of the unit)

Name and address of dealer \_\_\_\_\_

Attach your purchase receipt here.

## Accessory information

### Included accessories

- To order replacement accessories, call 1-800-332-5368.  
TTY users (hearing or speech impaired users) can call 1-866-605-1277.

No.	Accessory items	Order number	Quantity
①	AC adaptor for base unit	PQLV1W	1
②	Telephone line cord	PQJA10075Z	1
③	Battery	HHR-P104	1
④	Handset cover	PQYNTG2388BR	1
⑤	Belt clip	PQKE10375Z2	1
⑥	Shoulder rest attachment	PQKE10364Z1	1
⑦	Charger unit	Charger: PQLV30023NB	1
		AC adaptor: KX-TCA1-2	1

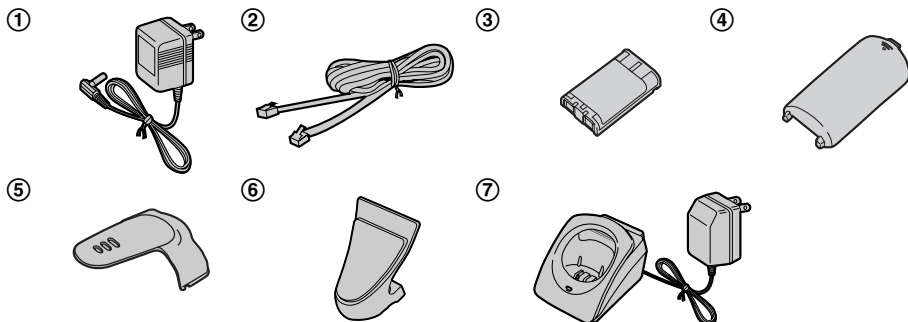

### Additional/replacement accessories

Accessory items	Order number
Rechargeable nickel metal hydride (Ni-MH) battery	HHR-P104
Headset	KX-TCA60, KX-TCA86, KX-TCA88HA, KX-TCA91, KX-TCA92, or KX-TCA98
Battery back-up power supply	KX-TCA200

---

---

## **Important safety instructions**

When using the product, basic safety precautions should always be followed to reduce the risk of fire, electric shock, or personal injury.

1. Read and understand all instructions.
2. Follow all warnings and instructions marked on the product.
3. Unplug the product from power outlets before cleaning. Do not use liquid or aerosol cleaners. Use a damp cloth for cleaning.
4. Do not use the product near water, for example near a bathtub, wash bowl, kitchen sink, etc.
5. Place the product securely on a stable surface. Serious damage and/or injury may result if the product falls.
6. Do not cover slots and openings on the product. They are provided for ventilation and protection against overheating. Never place the product near radiators, or in a place where proper ventilation is not provided.
7. Use only the power source marked on the product. If you are not sure of the type of power supplied to your home, consult your dealer or local power company.
8. Do not place objects on the power cord. Install the product where no one can step or trip on the cord.
9. Do not overload power outlets and extension cords. This can result in the risk of fire or electric shock.
10. Never push any objects through slots in the product. This may result in the risk of fire or electric shock. Never spill any liquid on the product.
11. To reduce the risk of electric shock, do not disassemble the product. Take the product to an authorized service center when service is required. Opening or removing covers may expose you to dangerous voltages or other risks.

Incorrect reassembly can cause electric shock when the product is subsequently used.

12. Unplug the product from power outlets and refer servicing to an authorized service center when the following conditions occur:
  - A. When the power cord is damaged or frayed.
  - B. If liquid has been spilled into the product.
  - C. If the product has been exposed to rain or water.
  - D. If the product does not work normally by following the operating instructions. Adjust only controls covered by the operating instructions. Improper adjustment may require extensive work by an authorized service center.
  - E. If the product has been dropped or physically damaged.
  - F. If the product exhibits a distinct change in performance.
13. During thunderstorms, avoid using telephones except cordless types. There may be a remote risk of an electric shock from lightning.
14. Do not use the product to report a gas leak, when in the vicinity of the leak.

## **SAVE THESE INSTRUCTIONS**

### **CAUTION:**

#### **Installation**

- Never install telephone wiring during a lightning storm.
- Never install telephone jacks in wet locations unless the jack is specifically designed for wet locations.
- Never touch uninsulated telephone wires or terminals unless the telephone line has been disconnected at the network interface.
- Use caution when installing or modifying telephone lines.

## Introduction

---

- Do not touch the plug with wet hands.
- The AC adaptor is used as the main disconnect device. Ensure that the AC outlet is installed near the product and is easily accessible.

### Battery

To reduce the risk of fire or injury to persons, read and follow these instructions.

- Use only the battery(ies) specified.
- Do not dispose of the battery(ies) in a fire. They may explode. Check with local waste management codes for special disposal instructions.
- Do not open or mutilate the battery(ies). Released electrolyte is corrosive and may cause burns or injury to the eyes or skin. The electrolyte may be toxic if swallowed.
- Exercise care when handling the battery(ies). Do not allow conductive materials such as rings, bracelets or keys to touch the battery(ies), otherwise a short circuit may cause the battery(ies) and/or the conductive material to overheat and cause burns.
- Charge the battery(ies) provided with or identified for use with the product only, in accordance with the instructions and limitations specified in this manual.

### WARNING:

- To prevent the risk of fire or electrical shock, do not expose this product to rain or any type of moisture.
- Unplug the product from power outlets if it emits smoke, an abnormal smell, or makes an unusual noise. These conditions can cause fire or electric shock. Confirm that smoke has stopped and contact the Panasonic Call Center at 1-800-211-PANA (7262).

---

### Medical

- Consult the manufacturer of any personal medical devices, such as

pacemakers or hearing aids, to determine if they are adequately shielded from external RF (radio frequency) energy. [The product operates in the frequency range of 2400 MHz to 2481 MHz, and the power output is 125 mW (max.)] Do not use the product in health care facilities if any regulations posted in the area instruct you not to do so. Hospitals or health care facilities may be using equipment that could be sensitive to external RF (radio frequency) energy.

---

---

## For best performance

### Base unit location/noise

The base unit and handset use radio waves to communicate with each other. For maximum distance and noise-free operation, we recommend the following:

- Placing the product away from electrical appliances such as a TV, personal computer, or another cordless phone.
- Placing the base unit in a HIGH and CENTRAL location with no obstructions such as walls.
- Raising the antenna vertically.
- If you use the handset near a microwave oven which is being used, noise may be heard. Move away from the microwave oven and closer to the base unit.
- If you use the handset near another cordless phone's base unit, noise may be heard. Move away from the other cordless phone's base unit and closer to your base unit.

### Environment

- Keep the product away from electrical noise generating devices, such as fluorescent lamps and motors.
- The product should be kept free from excessive smoke, dust, high temperature, and vibration.
- The product should not be exposed to direct sunlight.
- Do not place heavy objects on top of the product.
- When you leave the product unused for a long period of time, unplug the product from the power outlet.
- The product should be kept away from heat sources such as heaters, kitchen stoves, etc. It should not be placed in rooms where the temperature is less than 5 °C (41 °F) or greater than 40 °C (104 °F). Damp basements should also be avoided.

- The maximum calling distance may be shortened when the product is used in the following places: Near obstacles such as hills, tunnels, undergrounds, near metal objects such as wire fences, etc.
- Operating near 2.4 GHz electrical appliances may cause interference. Move away from the electrical appliances.

### Routine care

- Wipe the outer surface of the product with a soft cloth. Do not use benzine, thinner, or any abrasive powder.

# Connections

### Base unit

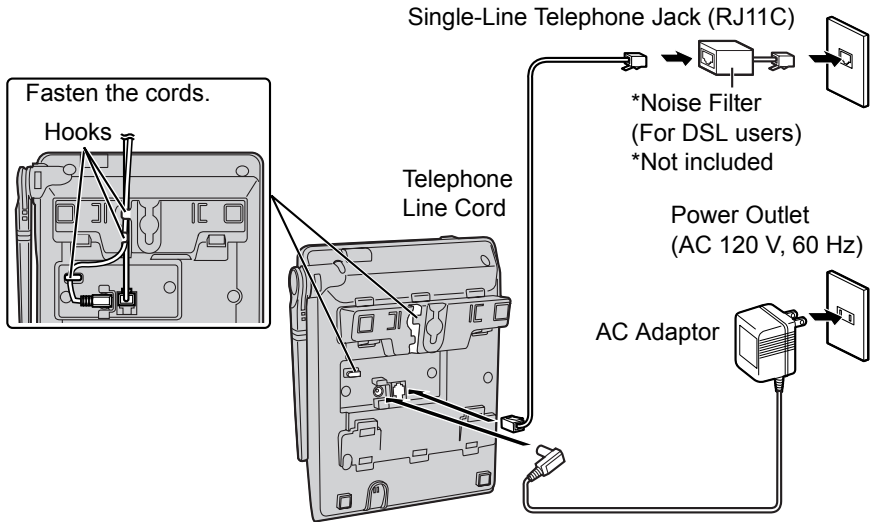

### Charger unit

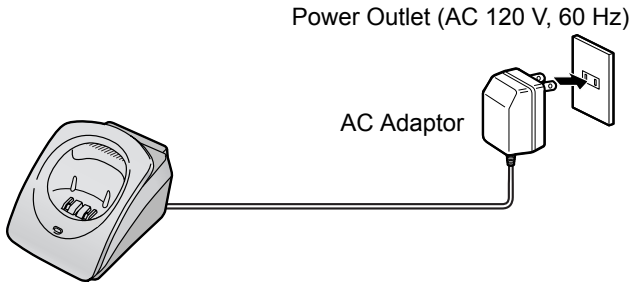

### Note:

- Base unit: Use only the included Panasonic AC adaptor PQLV1.
- Charger unit: Use only the included Panasonic AC adaptor KX-TCA1.
- The AC adaptors must remain connected at all times. (It is normal for the adaptors to feel warm during use.)
- The AC adaptors should be connected to a vertically oriented or floor-mounted AC outlet. Do not connect the AC adaptors to a ceiling-mounted AC outlet, as the weight of the adaptor may cause it to become disconnected.
- If your unit is connected to a PBX which does not support Caller ID, you cannot access Caller ID services.
- The unit will not work during a power failure. We recommend connecting a standard telephone to the same telephone line or to the same telephone jack using the Panasonic KX-J66 T-adaptor. Emergency power can be supplied to the unit by connecting a Panasonic battery back-up power supply noted on page 4.



### If you subscribe to a DSL service

- Please attach a noise filter (contact your DSL provider) to the telephone line between the base unit and the telephone line jack in the event of the following:
  - Noise is heard during conversations.
  - Caller ID features (page 27) do not function properly.

## Battery installation

- 1 Insert the battery (①), and press it down until it snaps into the compartment (②).

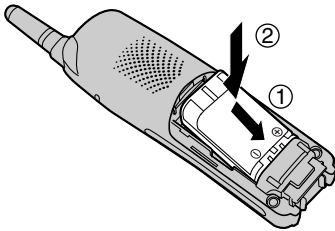

- 2 Close the handset cover.

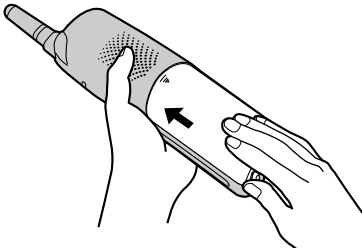

## Battery charge

Place the handset on the base unit or charger for **6 hours** before initial use.

- Make sure to place the handset with the keypad facing up to charge the handset battery. If the keypad is not facing up, the handset battery can not be charged.
- The unit will beep once, the CHARGE indicator will light, and "Charging" will be displayed.

- "Charge completed" is displayed when the battery has been fully charged. The CHARGE indicator will remain lit.

### Base unit

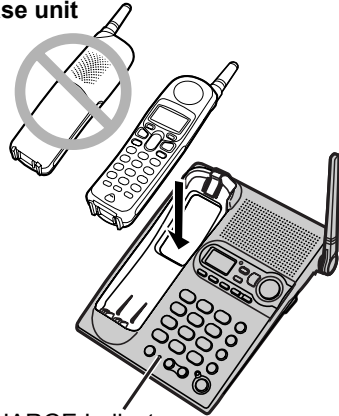

CHARGE Indicator

### Charger unit

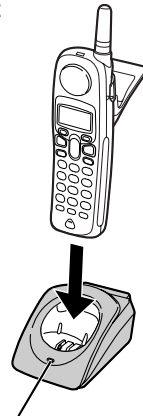

CHARGE Indicator

- If you attach the shoulder rest attachment to the handset (page 59), charge the handset using the charger.





### Note:

- To ensure the battery charges properly, clean the charge contacts of the handset, base unit and the charger with a soft, dry cloth once a month. Clean more often if the unit is subject to grease, dust, or high humidity.

## Preparation

### Battery strength

You can confirm the battery strength on the handset display.

Battery icon	Battery strength
	Fully charged
	Medium
	Low When flashing: needs to be recharged.
	Discharged

### Recharging the battery

Recharge the battery when:

- “**Recharge battery**” is displayed or  flashes on the handset display.
- the handset beeps intermittently while it is in use.

#### Note:

- Recharge the handset battery for more than 15 minutes, or the display will continue showing the indication.
- If the battery has been discharged, the handset will display “**Charge for 6h**” and  when you place the handset on the base unit or charger.

### Battery performance

After your Panasonic battery is fully charged, you can expect the following performance:

Operation	Operating time
While in use (talking)	Up to 5 hours
While not in use (standby) <sup>*1</sup>	Up to 11 days
While in use when the Hearing Aid mode is Telecoil (page 44)	Up to 2 hours



<sup>\*1</sup> Handset is off the base unit or charger but not in use.

#### Note:

- Battery power is consumed whenever the handset is off the base unit or charger, even when the handset is not in use. The longer you leave the handset off the base unit or charger, the shorter you can actually talk on the handset. Actual battery performance depends on a combination of how often the handset is in use and how often it is not in use.
- Once the battery is fully charged, you do not have to charge it again until “**Recharge battery**” is displayed or  flashes. This will maximize the battery life.

## Battery replacement

If battery performance diminishes, make sure you have cleaned the charge contacts and fully charged the battery. The battery needs to be replaced if any of the following are displayed after a few phone calls even when you have fully charged the battery.

- "Recharge battery"
-  (flashing)
- "Charge for 6h"
- 

● Use only the rechargeable Panasonic battery noted on page 4.

**1** Press the notch on the cover firmly and slide it as indicated by the arrow.

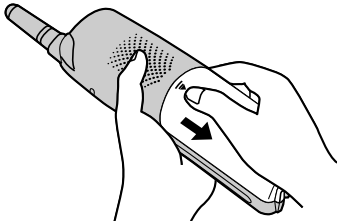

**2** Replace the old battery with a new one, and close the cover (see page 9 for battery installation).

### Attention:

A nickel metal hydride battery that is recyclable powers the product you have purchased.

Please call 1-800-8-BATTERY for information on how to recycle this battery.



## About the bone conduction earpiece

The handset features a bone conduction earpiece that uses vibrations, which allows you to hear your telephone conversations.

For proper operation press the bone conduction earpiece against a bone near the ear.

Normally, sound enters the ear canal and vibrates the eardrum. People feel the vibration within the inner ear and comprehend it as it is received by the auditory nerve.

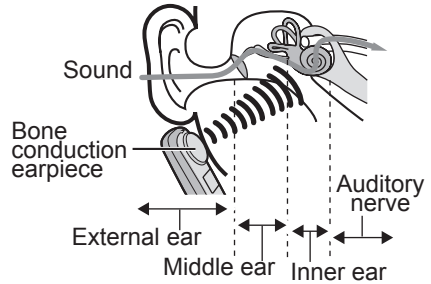

Place the bone conduction earpiece against your head (not your ear). Try different locations to find which location works best. Start with the temple area.

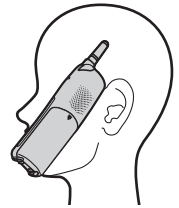

### Note:

- Do not place the bone conduction earpiece on a hearing aid. Howling or other interference may be heard.
- The effectiveness of the bone conduction earpiece will vary by the type and degree of hearing loss of the user.
- As sound is generated by vibration, users with normal hearing can use the handset by placing the bone conduction earpiece against the ear, as an ordinary telephone.
- If the bone conduction earpiece gets dusty or greasy, clean it with a soft, dry cloth.
- If noise is heard while using a hearing aid with telecoil or telephone mode on please refer to page 44.

## Controls and displays

### Controls

#### Base unit

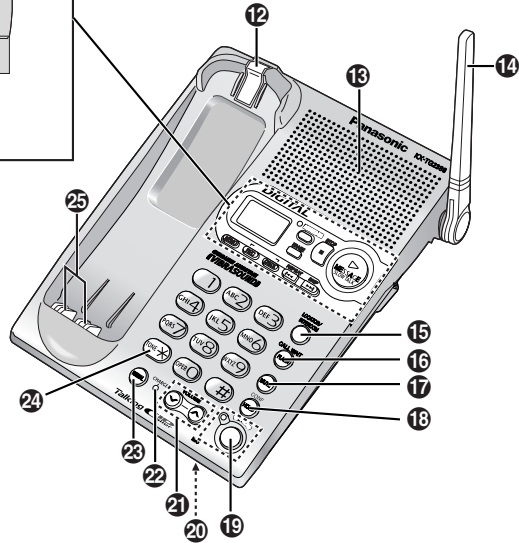
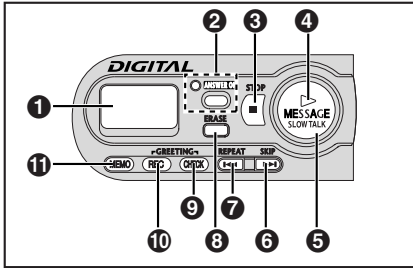

- |   |   |
|---|---|
| <b>1</b> Display                            | <b>13</b> Speaker   |
| <b>2</b> [ANSWER ON]<br>ANSWER ON indicator | <b>14</b> Antenna   |
| <b>3</b> [STOP]                             | <b>15</b> [LOCATOR/INTERCOM]                              |
| <b>4</b> NEW MESSAGE indicator              | <b>16</b> [FLASH/CALL WAIT]                               |
| <b>5</b> [MESSAGE/SLOW TALK]                | <b>17</b> [MUTE]  |
| <b>6</b> [SKIP]                             | <b>18</b> [HOLD/CONF] (Conference)                        |
| <b>7</b> [REPEAT]                           | <b>19</b> [SP-PHONE] (Speakerphone)<br>SP-PHONE indicator |
| <b>8</b> [ERASE]                            | <b>20</b> MIC (Microphone)                                |
| <b>9</b> [GREETING CHECK]                   | <b>21</b> VOLUME [V] [^]                                  |
| <b>10</b> [GREETING REC] (Recording)        | <b>22</b> CHARGE indicator                                |
| <b>11</b> [MEMO]                            | <b>23</b> [REDIAL]  |
| <b>12</b> Hook                              | <b>24</b> [*] (TONE)                                      |
|   | <b>25</b> Charge contacts                                 |

Handset

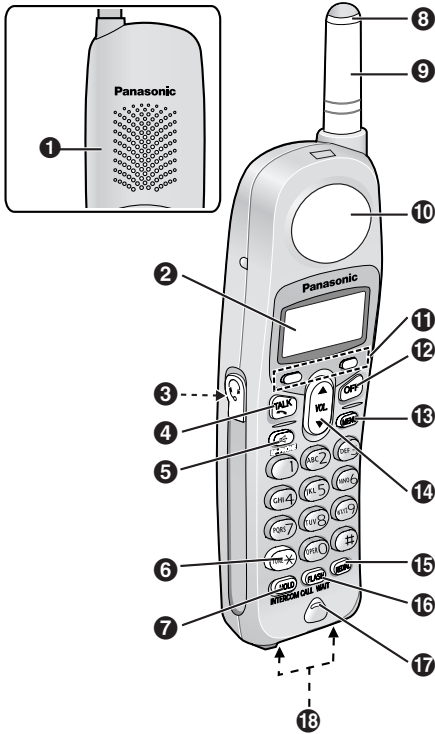

- 1 Speaker
- 2 Display
- 3 Headset jack
- 4 [↶] (TALK)
- 5 [↷] (SP-PHONE)
- 6 [\*] (TONE)
- 7 [HOLD/INTERCOM]
- 8 Ringer/Message Alert indicator
- 9 Antenna
- 10 Bone conduction earpiece
- 11 Soft keys
- 12 [OFF]
- 13 [MENU]
- 14 Navigator key ([▼], [▲])
- 15 [REDIAL]
- 16 [FLASH/CALL WAIT]
- 17 Microphone
- 18 Charge contacts

Charger unit

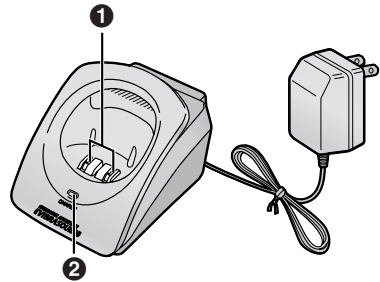

- 1 Charge contacts
- 2 Charge indicator

Using the navigator key



Scrolls up [▲] and down [▼] the function menu, the caller list and the phonebook. Increases [▲] or decreases [▼] the handset ringer and receiver/speaker volumes.

## Preparation

### Display

#### Base unit display items

Displayed item	Meaning
<b>FULL</b>	Flashes when message memory is full.
⌚	Flashes when the date and time need to be set.
<b>IN USE</b>	" <b>IN USE</b> " is displayed when a handset user is operating the Answering System, or when the Talking Keypad (page 44) or Name Announcement feature (page 44) is announcing a name or phone number.
<b>LINE</b> <b>IN USE</b>	Line is in use. When flashing: a call is on hold or the answering system is answering a call. When flashing rapidly: a call is being received.
<b>RINGER OFF</b>	Base unit ringer is off.
E	Greeting message recording error
☎	Answering system is in greeting only mode (caller messages will not be recorded).

#### Soft keys

The handset features 2 soft keys. By pressing a soft key, you can select the function displayed directly above it.

- The functions displayed will vary depending on how you are using the unit.
- When a function does not appear above a soft key, the soft key has no function.

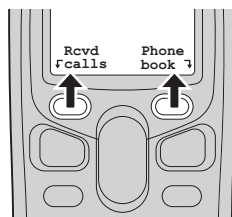

#### Note:

- In these operating instructions, soft key names are written inside brackets, the same way as other unit keys.

Example:

Unit keys: [**↶**], [**OFF**], etc.

Soft keys: [**Select**], [**Save**], etc.

#### Handset backlit display and handset keypad

The handset display and dialing buttons will light for a few seconds after pressing any of the handset's controls or lifting the handset off the base unit or charger. They will also light when an intercom/outside call is being received.

### Setting the unit before use

#### Handset display language

You can select either "English" or "Español" as the display language.

- 1 Press [**MENU**].
- 2 Scroll to "Initial setting" by pressing [**▼**] or [**▲**], then press [**Select**].
- 3 Scroll to "Change language" by pressing [**▼**] or [**▲**], then press [**Select**].
- 4 To change from English to Spanish, press [**Español**].  
To change from Spanish to English, press [**English**].

- The display changes to the selected language.
- You can also select a language by pressing [▼] or [▲].

**5** Press [**Save**] or [**Salvar**], then press [**OFF**].

**Note:**

- If you select a language you cannot read, press [**MENU**] [**0**] [**8**] [**1**] [**Save**] to change the display language to English.

### Setting the dialing mode

If you cannot make calls, change this setting depending on your telephone line service. The default setting is "Tone".  
 "Tone": For tone dial service.  
 "Pulse": For rotary pulse dial service.

- 1** Press [**MENU**].
- 2** Scroll to "Initial setting" by pressing [▼] or [▲], then press [**Select**].
- 3** Scroll to "Set tel line" by pressing [▼] or [▲], then press [**Select**].
- 4** Press [**Select**] at "Set dial mode".
- 5** Press [▼] or [▲] to select the desired setting.
- 6** Press [**Save**], then press [**OFF**].

### Setting the date and time

- 1** Press [**MENU**].
- 2** Scroll to "Date and time" by pressing [▼] or [▲], then press [**Select**].
- 3** ① Enter the current month, day, and year by selecting 2 digits for each.

Example: June 15, 2005  
 Press [**0**][**6**] [**1**][**5**] [**0**][**5**].

Date: 06.15.2005
Time: 12:00 AM
↓ AM/PM      Save ↓

- 2** Enter the current hour and minute (12-hour clock format) by selecting 2 digits for each.  
 Example: 9:30 PM  
 Press [**0**][**9**] [**3**][**0**].

Date: 06.15.2005
Time: 09:30 AM
↓ AM/PM      Save ↓

- 4** Select "AM" or "PM" by pressing [**AM/PM**].
- 5** Press [**Save**].
  - When the date and time are set, ☉ disappears from the base unit display.
  - If the handset beeps 3 times, the date and time were not set correctly. Enter the correct digits.
- 6** Press [**OFF**].

The date and time may be incorrect after a power failure. When ☉ flashes on the base unit display, set the date and time again.

#### To confirm the date and time

Repeat steps 1 and 2.

- The current date and time are displayed. When finished, press [**OFF**].

#### For Caller ID service users (page 27)

- When a call is received, Caller ID information adjust the date and time if the time is incorrect.
- Caller ID information will automatically adjust the date and time for daylight saving time.
- If the date and time has not previously been set, Caller ID information will not adjust the date and time.

### Making calls

#### Using the handset

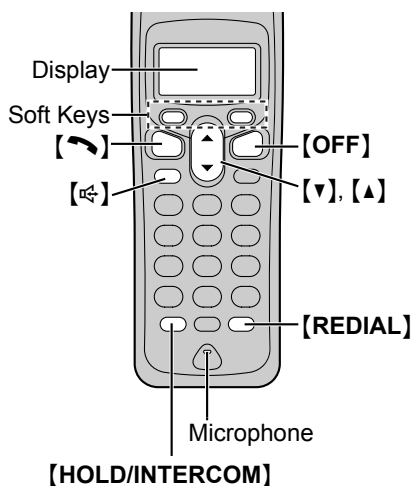

- 1 Lift the handset and press [↶].
  - "Talk" is displayed.
- 2 Dial the phone number.
- 3 When finished talking, press [OFF] or place the handset on the base unit or charger.

#### To use the speakerphone

- 1 Lift the handset and press [📞].
  - "SP-phone" is displayed.
- 2 Dial the phone number.
- 3 When the other party answers, speak into the microphone.
- 4 When finished talking, press [OFF] or place the handset on the base unit or charger.

#### Note:

- Talk alternately with the caller in a quiet room.

- If the other party has difficulty hearing you, press [▼] to decrease the speaker volume.
- While on a call, you can switch from the receiver to the speakerphone by pressing [📞]. To switch back to the receiver, press [↶].

#### To dial after confirming the entered number (Pre-dial)

- 1 Enter the phone number.
  - The handset announces each button you press, including [1] to [0], [\*] ("Star"), [#] ("Pound"), [FLASH/ CALL WAIT] ("Flash") and [Pause].
  - The announcement is heard at the speaker volume. To increase or decrease volume, press [▲] or [▼].
  - If you misdial, press [Clear]. Enter the correct number.
  - If a pause is required when dialing, press [Pause] where needed (page 17).
  - To cancel, press [OFF].
- 2 Press [↶] or [📞].
- 3 When finished talking, press [OFF] or place the handset on the base unit or charger.

#### Note:

- If the Handset Talking Keypad is turned off (page 44), the handset will not announce the buttons you press.

#### The handset will not make announcements, when:

- the Handset Talking Keypad is turned off
- the Answering System is in use
- the handset has lost communication with the base unit
- the base unit is announcing
- the base unit is making an outside call.



### PAUSE button (for PBX/long distance service users)

#### Using the handset

A pause is sometimes required when making calls using a PBX or long distance service.

For example, if you need to dial the line access number "9" when making outside calls with a PBX:

- 1 Press **[9]**.
- 2 Press **[Pause]**, then dial the phone number.

Example: 

- 3 Press **[↶]** or **[📞]**.

#### Note:

- A 3.5 second pause is inserted each time **[Pause]** or **[P]** is pressed. Press repeatedly to insert longer pauses.

### To adjust the receiver/speaker volume during a conversation

There are 6 volume levels for the receiver and the speaker.

To increase volume, press **[▲]**.

To decrease volume, press **[▼]**.

- The number of steps indicates the volume level.
- The display shows the current volume setting.
- If you try to increase/decrease volume when it is at the maximum/minimum level, the handset will beep 3 times.
- 3 levels (High, Medium and Low) are available while using the headset.

### To redial the last number dialed

- 1 Press **[↶]** or **[📞]**.
- 2 Press **[REDIAL]**.

### To redial using the redial list (Memory Redial)

The last 5 phone numbers dialed are stored in the redial list.

- 1 Press **[REDIAL]**.
  - The last number dialed is displayed.
  - "Redial" and the displayed name or phone number are announced.
- 2 Scroll to the desired number by pressing **[▼]** or **[▲]**.
  - The displayed name or phone number is announced each time you press **[▼]** or **[▲]** to scroll through the list.
  - The announcement is heard at the speaker volume. To increase or decrease volume, press **[MENU]** after you enter the list, then press **[▲]** or **[▼]**.
  - You can also scroll down through the list by pressing **[REDIAL]**.
  - To exit the list, press **[OFF]**.
- 3 Press **[↶]** or **[📞]**.
  - To erase an item, scroll to the item then press **[Erase]**.
  - If "No items stored" is displayed and "Redial No items stored" is announced, the list is empty.
  - If the item does not have a name, or if the name does not include letters, numbers, or the & ("Ampersand") symbol, the phone number is announced instead.
  - If the Name Announcement is turned off (page 44), the handset will not announce a name or a phone number displayed while you are searching.

### The handset will not make announcements, when:

- the Name Announcement is turned off
- the Answering System is in use
- the handset has lost communication with the base unit
- the base unit is announcing
- the base unit is making an outside call.

### To put a call on hold

- 1 Press **[HOLD/INTERCOM]** during a conversation.
  - “Line on hold.” is displayed.
- 2 Press **[HOLD/INTERCOM]** again.
  - “Hold” is displayed.
  - You can search the caller list or phonebook while a call is on hold. To exit the list, press **[OFF]**. The call will remain on hold.

To return to the call, press **[↶]** or **[↷]**.

### Note:

- The base unit user can also take the call by pressing **[SP-PHONE]**.
- If another phone is connected on the same line (page 8), you can also take the call by lifting its handset.
- If a call is kept on hold for 6 minutes, an alarm tone will start to sound and the Ringer/Message Alert indicator will start to flash rapidly. After 4 additional minutes on hold, the call will be disconnected.

### Using the base unit

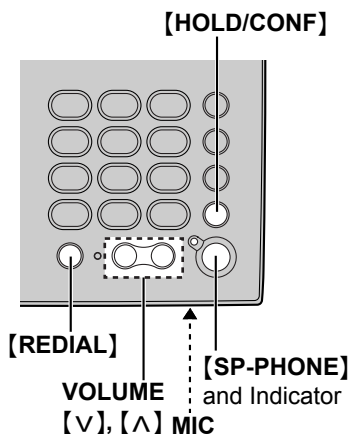

- 1 Press **[SP-PHONE]**.
  - The SP-PHONE indicator lights.
  - “**LINE IN USE**” displays.
- 2 Dial a phone number.
  - The base unit announces each button you press, including **[1]** to **[0]**, **[\*]** (“Star”), **[#]** (“Pound”), and **[FLASH/CALL WAIT]** (“Flash”).
- 3 When the other party answers, talk into the **MIC** (microphone).
- 4 To hang up, press **[SP-PHONE]**.
  - The indicator light goes out.

### Note:

- To switch to the handset while using the base unit speakerphone:
  - If the handset is off the base unit or charger, press **[↶]** or **[↷]** on the handset, then press **[SP-PHONE]** on the base unit.
  - If the handset is on the base unit, just lift up the handset.
- If the Base Unit Talking Keypad is turned off (page 44), the base unit will not announce the entered number.

### The base unit will not make announcements, when:

- the Base Unit Talking Keypad is turned off
- the Answering System is in use using the handset
- the handset is announcing.

### Hands-free Digital Duplex Speakerphone

For best performance, please note the following:

- Talk alternately with the other party in a quiet room.
- If you or the other party has difficulty hearing the conversation, press **VOLUME [V]** to decrease the speaker volume.

### To adjust the speaker volume during a conversation

To increase volume, press **VOLUME [^]**.  
To decrease volume, press **VOLUME [v]**.

- There are 8 volume levels. If you try to increase/decrease volume when it is at the maximum/minimum level, the base unit will beep 3 times.
- The selected volume level is displayed while you are adjusting the volume.

### To redial the last number dialed

Press **[SP-PHONE]**, then press **[REDIAL]**.

- "Redial" is announced.
- If the Base Unit Talking Keypad is turned off (page 44), the base unit will not announce.

### To put a call on hold

Press **[HOLD/CONF]** during a conversation.

- The SP-PHONE indicator flashes.  
To return to the call, press **[SP-PHONE]**.
- The handset user can also take the call by pressing **[↶]** or **[↷]**.

- If another phone is connected on the same line (page 8), you can also take the call by lifting its handset.
- If a call is kept on hold for 6 minutes, an alarm tone will start to sound. After 4 additional minutes on hold, the call will be disconnected.

### Answering calls

When a call is received, the unit rings, "Incoming call" is displayed, and the Ringer/Message Alert indicator on the handset and "LINE IN USE" on the base unit flash rapidly. If you subscribe to Caller ID, see page 27.

### Using the handset

Ringer/Message  
Alert Indicator

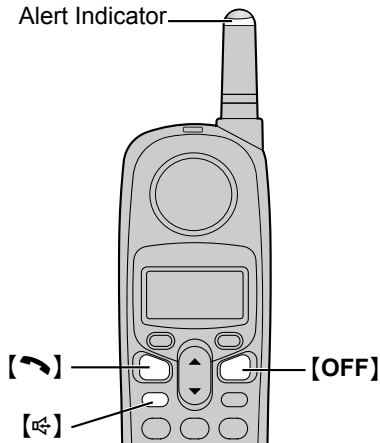

- 1 Lift the handset and press [↶] or [🔊].
  - You can also answer a call by pressing any button except [▼], [▲], or [OFF]. (Any key talk feature)
- 2 When finished talking, press [OFF] or place the handset on the base unit or charger.

### Auto talk

This feature allows you to answer a call by simply lifting the handset off the base unit or charger. You do not need to press [↶]. To activate this feature, see page 43.

### Temporary ringer off

While the handset is ringing for an outside call, you can turn the ringer off temporarily by pressing [OFF]. The handset will ring the next time a call is received.

### Using the base unit

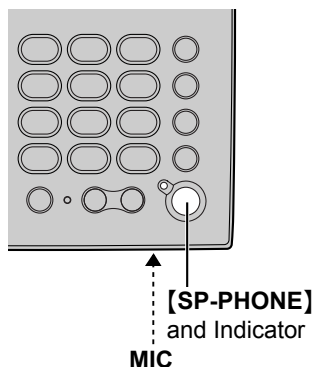

- 1 Press [SP-PHONE].
- 2 Talk into the MIC.
- 3 To hang up, press [SP-PHONE].

- To transfer the call to another person, see page 33.
- If the ringer volume is turned off, the unit will not ring (page 39).

### Useful features during a call

#### MUTE button

You can mute your voice during a conversation. While mute is turned on you will be able to hear the other party, but the other party will not be able to hear you.

#### Using the handset

Press [Mute].

- "Mute" will flash.
- To release the mute, press [Mute] again.
- If you press [↶] or [🔊] to switch between the receiver and speaker, the mute will be released.

#### Using the base unit

Press [MUTE].

- The SP-PHONE indicator flashes.
- To release the mute, press **[MUTE]** again.

---

### FLASH button

---

#### Using the handset or base unit

Pressing **[FLASH/CALL WAIT]** allows you to use special features of your host PBX such as transferring an extension call, or accessing optional telephone services such as Call Waiting.

#### Note:

- Pressing **[FLASH/CALL WAIT]** cancels temporary Tone Dialing mode or the mute (page 15).
- To change the flash time, see page 43.

---

### For Call Waiting service users

---

#### Using the handset or base unit

To use Call Waiting, you must subscribe to your telephone company's Call Waiting service.

This feature allows you to receive calls while you are already talking on the phone. If you receive a call while on the phone, you will hear a Call Waiting tone.

Press **[FLASH/CALL WAIT]** to answer the 2nd call.

- The 1st call is put on hold while you answer the 2nd call.
- To switch between calls, press **[FLASH/CALL WAIT]**.
- Call Waiting service cannot be used when the first call is put on hold, or the Answering System is handling a call.
- If this function does not operate properly, consult your telephone company for details.

#### Note:

- Please contact your telephone company for details and availability of this service in your area.

---

### Call Waiting Caller ID display

If you subscribe to both Caller ID and Call Waiting with Caller ID services (CWID), when a second call is received while talking using the handset, the second caller's information will be displayed. After you hear a call waiting tone while talking, the display shows the caller's name with the phone number and "----Waiting----".

#### Note:

- Contact your telephone company for details about availability in your area, and to verify that CWID is activated on your telephone line.
- The caller's information will only be shown on the display of the handset which is on the outside call.
- The second caller's name will not be announced even if the Talking Caller ID feature is on (page 41).

---

### Temporary tone dialing (for rotary/pulse service users)

You can temporarily switch the dialing mode to tone when you need to access touch tone services (for example, answering services, telephone banking services, etc.).

Press **[\*]** (TONE) on the handset or the base unit before entering access numbers which require tone dialing.

#### Note:

- The dialing mode will return to pulse when you hang up.

## Using the phonebook

The handset phonebook allows you to make calls without having to dial manually. You can add 50 names and phone numbers to its phonebook and search for phonebook entries by name.

## Adding items to the phonebook using the handset

1 Press **[Phone book]** (right soft key).

- “Phone book” is announced.

2 Press **[Add]**.

Enter name █
-----------------

3 Enter the name (max. 16 characters).

See the character table for entry, then press **[v]**.

4 Enter the phone number (max. 32 digits).

- Each time you press **[←]**, a digit is erased. To erase all of the digits, press and hold **[←]**.
- If a pause is required when dialing, press **[P]** where needed (page 17).

Enter phone no.  P ↓
----------------------------

5 Press **[v]**.

- If you want to change the name, press **[Edit]**. The display returns to step 3. Change the name.
- If you want to change the number, press **[▲]**. The display returns to step 4. Change the number.

6 Press **[Save]**.

- To add other items, repeat from step 2.

7 Press **[OFF]**.

### Note:

- To store numbers for calling card access (see “Chain Dial” on page 24), we recommend you add pauses after each item. Storing pauses with numbers will prevent misdialing (page 17). The delay time necessary will depend on your telephone company.

### Character table

The dial keys can be used to enter characters. To enter a character, press the appropriate dial key, repeatedly if necessary. To enter another character that is located on the same dial key, first press **[▶]** to move the cursor to the next space.

Key	Characters
[1]	# & ' ( ) * , - . / 1
[2]	a b c A B C 2
[3]	d e f D E F 3
[4]	g h i G H I 4
[5]	j k l J K L 5
[6]	m n o M N O 6
[7]	p q r s P Q R S 7
[8]	t u v T U V 8
[9]	w x y z W X Y Z 9
[0]	0 Space
[←]	Erases the character to the left.
[▶]	Moves the cursor to the right.

### For Name Announcement users

(page 44)

When entering initials or acronyms, we recommend inserting a space between each letter.

For example, to store the initials “ABC”, enter a space after the A and B as shown.

A B C █
---------

**To correct a mistake**

Use [←] to erase the incorrect character. Each time you press [←], a character is erased. Re-enter the correct character.

**Note:**

- Press and hold [←] to erase all characters or numbers.

**Calling someone in the phonebook**

Phonebook items can be searched for alphabetically by scrolling through the phonebook items.

- 1 Press [Phone book] (right soft key).
  - For quick search, you can skip to step 3.

- 2 Press [Search].

0-9=Name search  
▼▲=Scroll list

- 3 Press [▼] or [▲] repeatedly to display the desired item.
  - To exit the phonebook, press [OFF].

- 4 Press [↶] or [↷].
  - If “No items stored” is displayed and “Phone book No items stored” is announced in step 1, the phonebook is empty.
  - To view a phone number over 16 digits long, repeat steps 1 to 3, then press [Edit] and then [▼]. When finished, press [OFF].

**To search for a name by initial**

- 1 Press [Phone book] (right soft key).
- 2 Press [Search].
- 3 Press the dialing button for the first letter of the desired name until any name with the same initial is displayed. Ex. To find “Frank”, press [3]

repeatedly until the first item under “F” is displayed.

- If there are no items beginning with the character you selected, the first item in the next alphabetical index will be displayed.

- 4 Press [▼] repeatedly until the desired name is displayed.

**Name Announcement**

Name Announcement (page 44) is a feature that announces names or phone numbers shown on the display while you are using the handset to search the phonebook, caller list, redial list, and one-touch dialer, allowing you to confirm displayed items audibly before making calls.

Operation	Announcement
When you press [Phone book]	“Phone book” is announced.
When you press [▼], or [▲] to search an item	The displayed name or phone number is announced, each time you scroll an item by pressing [▼] or [▲].

- If the item does not have a name, or if the name does not include letters, numbers, or the & (“Ampersand”) symbol, the phone number is announced instead.
- The announcement is heard at the speaker volume (page 17). Perform the following steps while searching:
  - (1) press [MENU],

1=1-touch dial  
2=Volume  
↵Back

- (2) press [2] and
- (3) press [▲] or [▼] to increase or decrease volume.

## Phonebook

---

- “2=volume” will not be displayed when the Name Announcement is turned off.
- If the Name Announcement is turned off (page 44), the handset will not announce the name or phone number displayed on the handset.

### The handset will not make announcements, when:

- the Name Announcement is turned off
- the Answering System is in use
- the handset has lost communication with the base unit
- the base unit is announcing
- the base unit is making an outside call.

---

### Chain dial feature using the handset

This feature allows you to dial phone numbers from the phonebook while you are on a call.

Example: Using a long distance calling card

- ① Dial from the phonebook:  
1-800-012-3456 (Calling card access number).
- ② When prompted, dial from the phonebook:  
1234 (Calling card PIN).
- ③ When prompted, dial from the phonebook:  
1-555-012-3456 (the person you want to call).

- 1** During an outside call, press **[MENU]**.
- 2** Search for the desired item by pressing **[▼]** or **[▲]**.
- 3** Press **[Call]**.
  - The phone number is dialed.
  - If required, repeat steps 1 to 3 for any remaining numbers.

### Note:

- When storing a calling card access number and your PIN in the phonebook as one phonebook item, press **[P]** to add pauses after the number and PIN as necessary (page 17).
- If you have rotary or pulse service, you need to press **[\*]** before pressing **[MENU]** in step 1 to change the dialing mode temporarily to tone.

---

### Editing items in the phonebook

- 1** Press **[Phone book]** (right soft key).
- 2** Press **[▼]** or **[▲]** repeatedly to display the desired item.
- 3** Press **[Edit]**.
- 4** Edit the name if necessary. See the character table on page 22 for character entry.
- 5** Press **[▼]**.
- 6** Edit the phone number if necessary.
- 7** Press **[▼]**, then press **[Save]**.
  - To edit other items, repeat from step 2.
- 8** Press **[OFF]**.

---

### Erasing items in the phonebook

- 1** Press **[Phone book]** (right soft key).
- 2** Press **[▼]** or **[▲]** repeatedly to display the desired item.
- 3** Press **[Erase]**.
  - To cancel erasing, press **[No]**.
- 4** Press **[Yes]**.
  - To erase other items, repeat from step 2.
- 5** Press **[OFF]**.



## Storing an item in the phonebook to the one-touch dialer using the handset

Caller names and phone numbers that are in the phonebook can be assigned to the dialing buttons ([0] to [9]) for easy dialing.

- 1 Press **[Phone book]** (right soft key).
  - “Phone book” is announced.
- 2 Press **[Search]**.
- 3 Scroll to the desired item by pressing **[v]** or **[^]**, then press **[MENU]**.

1=1-touch dial  
2=Volume

- The displayed name or phone number is announced, each time you scroll an item by pressing **[v]** or **[^]**.
  - To search for the item by initial, see (page 23).
- 4 Press **[1]**.
    - “2=Volume” will not be displayed when the Name Announcement is turned off.
  - 5 Scroll to the desired registration number by pressing **[v]** or **[^]**.
    - The empty registration number is selected automatically. (For example The empty number is “5”.)

Select 1-touch #  
5: (No data)

- You can also select the desired registration number by pressing dialing buttons ([0] to [9]).
- 6 Press **[Save]**.
    - To continue storing other items, repeat from step 3.

If the registration number selected manually is occupied, the display below will be shown.

Overwrite?

To overwrite, press **[Yes]**.

To select other empty registration number, press **[No]**, then repeat steps 5 and 6.

### 7 Press **[OFF]**.

#### Note:

- If the phonebook item stored in the one-touch dialer is deleted from the phonebook or edited, the item in the one-touch dialer is also deleted or edited.

## Dialing a stored number using the handset

- 1 Press and hold the desired dialing button ([0] to [9]) until the item is displayed.
  - If no item is stored in the button you pressed, the unit will not enter the one-touch dialer.
  - You can also search the desired item by pressing **[v]** or **[^]**.
- 2 Press **[↶]** or **[↷]**.
  - The displayed phone number is dialed.

#### Note:

- If the Answering System is in use when the Name Announcement is turned on (page 44), the handset will not announce.

### Name announcement

Name Announcement (page 44) is a feature that announces names or phone numbers shown on the display while you are using the handset to search the phonebook, caller list, redial list, and one-touch dialer, allowing you to confirm

# One-Touch Dialer

displayed items audibly before making calls.

Operation	Announcement
When you press and hold a required dialing button ([0] to [9]) to dial from the one-touch dialer.	"1-touch dial" and displayed name or phone number are announced.
When you press [▼] or [▲] to search an item	The displayed name or phone number is announced, each time you scroll an item by pressing [▼] or [▲].

- If the item does not have a name, or if the name does not include letters, numbers, or the & ("Ampersand") symbol, the phone number is announced instead.
- The announcement is heard at the speaker volume (page 17). To increase or decrease volume, press [MENU] after you enter the list, then press [▲] or [▼].
- If the Name Announcement feature is turned off (page 44), the handset will not announce the name or phone number displayed on the handset.

**The handset will not make announcements, when:**

- the Name Announcement is turned off
- the Answering System is in use
- the handset has lost communication with the base unit
- the base unit is announcing
- the base unit is making an outside call.

## Erasing items using the handset

- 1 Press and hold the dialing button ([0] to [9]) you want to erase.
- 2 Press [Erase].
- 3 Press [Yes].
  - To erase other items, scroll to the desired items by pressing [▼] or [▲], then repeat from step 2.
- 4 Press [OFF].
  - To cancel erasing, press [No] after step 2.
  - If the phonebook item stored in one-touch dial is deleted from the phonebook or edited, the item in the one-touch dialer is also deleted or edited.
  - Even if the item in the one-touch dialer is deleted, the corresponding item in the phonebook will not be deleted.

## Using Caller ID service

This unit is Caller ID compatible. To use Caller ID features, you must subscribe to your telephone company's Caller ID service.

### How Caller ID information is displayed and announced

When a call comes in, the unit will ring and Caller ID information will be received. The handset display will show the caller's information, then the handset and base unit will announce the displayed name (for example "Call from ROBINSON, TINA") following every ring (**Talking Caller ID feature**).

Example: 

ROBINSON, TINA 1-555-222-3333
----------------------------------

- After you answer the call, the display will show the length of the call.
- The handset and base unit announce the caller's name repeatedly until the call is answered.
- If the unit cannot receive caller information, the following will be displayed:
  - "Out of area": The caller dialed from an area which does not provide Caller ID service.
  - "Private caller": The caller requested not to send caller information.
  - "Long distance": The caller called you long distance.
- While listening to a message recorded by the answering system, using the handset, you can call back the caller without having to dial the phone number (page 51).
- If the unit is connected to a PBX system, caller information may not be received properly. Consult your PBX supplier.
- Depending on the radio communications with the base unit, the handset may not

display Caller ID information immediately after the first ring.

- Name display service may not be available in some areas. For further information, please contact your telephone company.
- If you subscribe to both Caller ID and Call Waiting with Caller ID services (CWID), when a second call is received while talking, a call waiting tone will be heard and the second caller's information will be displayed on the handset in use (page 21). Contact your telephone company for details about availability in your area, and to verify that CWID is activated on your telephone line.

### Call Waiting Caller ID display

If you subscribe to both Caller ID and Call Waiting with Caller ID services, the 2nd caller's information will be displayed after you hear a Call Waiting tone (page 21).

#### Note:

- Please contact your telephone company for details and availability of this service in your area.

## Talking Caller ID

This feature allows you to know who is calling without looking at the display. When a call comes in, the handset and base unit will announce the caller's name displayed on the handset following every ring.

To use this feature, you must subscribe to your telephone company's Caller ID service.

- If the unit does not receive Caller ID information, the unit will announce "Call from out of area", "Call from private caller", or "Call from long distance".
- If a call is received from an area where name display service is not available, "Number available" will be announced.
- If the ringer volume of the handset and base unit is turned off, caller names will

## Caller ID Service

not be announced. The announcement is heard at ringer volume (page 39).

- If this feature is turned off, caller names will not be announced (see page 41).
- When you receive a call while on the phone, the 2nd caller's name will not be announced even if you subscribe to both Caller ID and Call Waiting with Caller ID services.
- Name pronunciation may vary. This feature may not pronounce all names correctly.
- The unit will announce each letter of abbreviations, such as "Co." and "Inc."
- Caller ID supports names of up to 15 letters. If the caller's name has more than 15 letters, the name will not be displayed or announced correctly.
- If you subscribe to a distinctive ring service (such as IDENTA-RING), your unit may mute one or more of the rings in order to announce the name of the caller.
- Usually the unit will announce the caller's name after the 2nd ring. If you turn on the answering system, and set the number of rings to "2" (page 54), the unit will not announce the caller's name. If "Toll saver" is selected, and there is a new message, the unit will not announce the caller's name.

## Caller list

Caller information for the last 50 different callers will be logged in the caller list. You can use this list to return missed calls.

- Caller information includes caller names and phone numbers, the date and time of calls, and the number of times the caller called.

### Missed calls

The unit will also tell you how many calls you missed while you were out or unavailable to answer the phone.

Handset on the base unit or charger

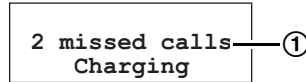

Handset off the base unit or charger

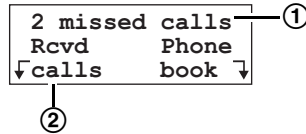

- ① The display will show the number of calls you missed.
- ② Press [**Rcvd calls**] to review other calls logged in the caller list.
  - If there are no items in the caller list, "Rcvd calls" will not be displayed.
  - After viewing the missed call entries, "missed calls" will disappear from the display.
- When new messages have been recorded (page 49), "New message" will be displayed in place of missed calls display.

## Viewing the caller list using the handset

- 1 Press [**Rcvd calls**], [**▼**], or [**▲**].

**2** To search from the most recent call, press [▼]. To search from the oldest call, press [▲].

- The caller's name, number and the time and date of the call are displayed. Name and phone number are alternately displayed as shown.

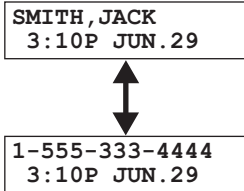

**3** Press [OFF].

**Note:**

- If there is no name information for a caller, the display will only show the phone number.
- If you do not press any buttons for 60 seconds, the unit will exit the caller list.

**Name announcement**

Name Announcement (page 44) is a feature that announces names or phone numbers shown on the display while you are using the handset to search the phonebook, caller list, redial list, and one-touch dialer, allowing you to confirm displayed items audibly before making calls.

Operation	Announcement
When you press [Rcvd calls], [▼], or [▲] to enter the caller list	The number of missed calls is announced. <ul style="list-style-type: none"> <li>• If a missed call does not exist, "no missed calls" is announced.</li> </ul>

When you press [▼] or [▲] to search an item	The displayed name or phone number is announced, each time you scroll an item by pressing [▼] or [▲].
---	---

- If the item does not have a name, or if the name does not include letters, numbers, or the & ("Ampersand") symbol, the phone number is announced instead.
- If a call does not have Caller ID information, the handset will announce "Out of area", "Private caller" or "Long distance".
- The announcement is heard at the speaker volume (page 17). To increase or decrease volume, press [MENU] after you enter the list, then press [▲], or [▼].
- If the Name Announcement is turned off (page 44), the handset will not announce the name or phone number displayed on the handset.

<p><b>The handset will not make announcements, when:</b></p> <ul style="list-style-type: none"> <li>• the Name Announcement is turned off</li> <li>• the Answering System is in use</li> <li>• the handset has lost communication with the base unit</li> <li>• the base unit is announcing</li> <li>• the base unit is making an outside call.</li> </ul>
--

**Displayed symbols**

- If the same caller calls more than once, it will be displayed with the number ("x2" to "x9"). Only the date and time of the most recent call will be stored.
- A ✓ is displayed next to items which have already been viewed or answered on this handset.

## Caller ID Service

---

### Calling Back using the handset

- 1 Press [**Rcvd calls**], [**▼**], or [**▲**].
- 2 Scroll to the desired caller by pressing [**▼**] or [**▲**].
- 3 Press [**↶**], or [**☎**].
  - The phone number is dialed.

#### Note:

- In some cases, you may have to edit the number before dialing.  
(For example You may have to delete “1” and the area code.)
- If a phone number is not displayed in the caller information, you cannot call that caller back from the caller list.

---

### Editing a caller’s phone number before calling back using the handset

You can edit a phone number in the caller list by removing its area code and/or the long distance code “1”.

- 1 Press [**Rcvd calls**], [**▼**], or [**▲**].
- 2 Press [**▼**] or [**▲**] repeatedly to display the desired item.
- 3 Press [**Select**].
- 4 Press [**Edit**] repeatedly until the phone number is shown in the desired format. Each time you press [**Edit**], the phone number will be rearranged into one of 3 patterns.
  - ① Local phone number  
Example:
  - ② Area code – Local phone number  
Example:
  - ③ 1 – Area code – Local phone number  
Example:

- 5 Press [**↶**] or [**☎**] to call back.

#### Note:

- If Caller ID Number Auto Edit is turned on (factory preset is on), phone numbers with the same area code as the number you edited will now be updated in the caller list and each time you receive a call.
- You can press [**OFF**] immediately after pressing [**↶**] or [**☎**] if you wish to activate the Auto Edit feature without actually dialing the number you just edited.

---

### Caller ID number auto edit feature using the handset

Once you call back an edited number (see “Editing a caller’s phone number before calling back using the handset”), the unit can automatically edit other incoming phone numbers each time you receive a call.

For example, you can use this feature to set the unit to ignore the area code of callers in your area code, so that you can call these local numbers using caller information without dialing the area code. To activate this feature, you must edit an item in the caller list (see “Editing a caller’s phone number before calling back using the handset”), then call that number. After that, calls from that caller’s area code will be edited automatically.

This feature can be turned on or off (page 42). The default setting is ON.

#### Note:

- The handset can remember up to 4 area codes to be edited. Phone numbers from the 4 most recently edited area codes will be automatically edited.
- This feature will not be activated until edited numbers are called back.
- If you move to another area, you can turn this feature off to erase previously edited area codes. To use this feature

again, turn it on and reprogram the area codes you want to edit once again.

---

## Storing caller information into the phonebook using the handset

Items in the caller list can be stored into the phonebook.

- 1 Press [**Rcvd calls**], [**▼**], or [**▲**].
- 2 Press [**▼**] or [**▲**] repeatedly to display the desired item.
- 3 Press [**Select**].
  - If the number requires editing, see page 30.
- 4 Press [**Save**].
  - If there is no name information for the caller, "**Enter name**" will be displayed.  
You can enter a name by performing the following steps:
    - ① Enter the name if necessary (see page 22, step 3).
    - ② Press [**▼**], then press [**Save**].If a name is not required, press [**▼**], then press [**Save**].
    - To continue storing other items, repeat from step 2.
- 5 Press [**OFF**] to exit.

### Note:

- If the caller information does not include a phone number, you cannot store it in the phonebook.

---

## Erasing caller information using the handset

---

### Erasing a selected item

- 1 Press [**Rcvd calls**], [**▼**], or [**▲**].
- 2 Scroll to the desired caller by pressing [**▼**] or [**▲**], then press [**Erase**].

- To erase other items, repeat from step 2.
- To exit the caller list, press [**OFF**].

---

### Erasing all items

Make sure that you have no missed calls.

- 1 Press [**Rcvd calls**], [**▼**], or [**▲**].
- 2 Press [**All erase**].
- 3 Press [**Yes**].
  - All entries in your caller list are erased.

### Locator/Intercom

Intercom calls can be made between the handset and the base unit.

#### Making intercom calls

##### Using the handset

- 1 Press **[HOLD/INTERCOM]**.

Calling Base

- The base unit will ring for 1 minute.
- To stop paging, press **[OFF]**.

- 2 When the paged party answers, start talking.

Intercom  
00-00-05

- You can switch to the speaker by pressing **[🔊]**. To switch back to the receiver, press **[🔇]**.

- 3 To disconnect the intercom, press **[OFF]**.

##### Using the base unit

- 1 Press **[LOCATOR/INTERCOM]**.

- The SP-PHONE indicator lights.
- The handset will ring for 5 minutes.
- To stop paging, press **[SP-PHONE]** or **[LOCATOR/INTERCOM]**.

- 2 When the paged party answers, talk into the **MIC**.

- 3 To disconnect the intercom, press **[SP-PHONE]** or **[LOCATOR/INTERCOM]**.

- The indicator light goes out.

##### During an intercom call:

- If you have difficulty hearing while using the handset speakerphone and base unit speaker, decrease the speaker volume by pressing **VOLUME [v]** on the base unit or **[v]** on the handset.
- If an incoming call is being received, you will hear two tones (incoming call tone, page 40) and "**LINE IN USE**" will flash rapidly on the base unit. To answer the call;
  - if using the handset, press **[OFF]**, then **[🔇]** or **[🔊]**.
  - if using the base unit, press **[SP-PHONE]** twice.

#### Answering intercom calls

##### Using the handset

When a handset is paged, it rings and the Ringer/Message Alert indicator flashes rapidly.

- 1 Press **[🔇]**, **[🔊]** or **[HOLD/INTERCOM]**.

Call from Base

- You can also answer a call by pressing any button except **[v]**, **[▲]** or **[OFF]**.

- 2 To disconnect the intercom, press **[OFF]**.

##### Using the base unit

When the base unit is being paged, it rings.

- 1 Press **[SP-PHONE]** or **[LOCATOR/INTERCOM]**.

- 2 To disconnect the intercom, press **[SP-PHONE]** or **[LOCATOR/INTERCOM]**.



- When the ringer volume is turned off (page 39), the handset and the base unit will ring at the low level for intercom calls.
- You cannot change the ringer tone for intercom calls.

## Transferring a call

You can transfer an outside call to the base unit or the handset.

### From the handset to the base unit

#### 1 Handset:

- (1) During a call, press [**HOLD/INTERCOM**].

Line on hold.  
Transfer to  
↓Base

- The call is put on hold.

- (2) Press [**Base**].

Hold  
Calling Base

- (3) Wait for the paged party to answer, then you can announce the transfer.

- After the paged party answers, "Intercom hold" is displayed.
- If the paged party does not answer, press [**↶**] or [**↷**] to return to the outside call.

#### 2 Base unit:

Press [**SP-PHONE**] or [**LOCATOR/INTERCOM**] to answer the page.

#### 3 Handset:

To complete the transfer, press [**OFF**].

### From the base unit to the handset

#### 1 Base unit:

During a call, press [**LOCATOR/INTERCOM**].

- The call is put on hold.
- If the paged party does not answer, press [**LOCATOR/INTERCOM**] to return to the outside call.

#### 2 Handset:

Press [**↶**], [**↷**] or [**HOLD/INTERCOM**] to answer the page.

- You can also answer a call by pressing any button except [**▼**], [**▲**] or [**OFF**].

#### 3 Base unit:

To complete the transfer, press [**SP-PHONE**].

## Quick call transfer

You can transfer a call without waiting for the paged party to answer.

### Using the handset

- 1 During a call, press [**HOLD/INTERCOM**], then press [**Base**].

- 2 Press [**OFF**] to hang up.

### Using the base unit

- 1 During a call, press [**LOCATOR/INTERCOM**].

- 2 Press [**SP-PHONE**] to hang up.

- The call will be transferred directly.
- For the paged party to answer the transferred call:
  - for the handset, press [**↶**] or [**↷**].
  - for the base unit, press [**SP-PHONE**].
- After the paged party answers, the transfer is complete.
- If the paged party does not answer:
  - for the handset, press [**↶**] or [**↷**].
  - for the base unit, press [**SP-PHONE**].
- If the paged party does not answer within 60 seconds after you hang up, your phone will ring and the call will be returned to your phone.  
To speak to the caller again:

## Locator/Intercom

---

- for the handset, press [**📞**] or [**📞**] to return to the outside call.
- for the base unit, press [**SP-PHONE**] to return to the outside call.

---

## Conference calls

While you are talking with an outside caller, the base unit user or the handset user can join the conversation and establish a conference call.

---

### Using the handset

- 1** During a call, press [**HOLD/INTERCOM**].
  - The call is put on hold.
- 2** Press [**Base**].
- 3** When the paged party answers, press [**Conf**] on your unit to make a conference call.
  - “**Conference**” is displayed during a conference call.

---

### Using the base unit

- 1** During a call, press [**LOCATOR/INTERCOM**].
  - The call is put on hold.
- 2** When the paged party answers, press [**HOLD/CONF**] on your unit to make a conference call.

#### Note:

- To leave the conference, press [**OFF**] on the handset or press [**SP-PHONE**] on the base unit. The two other parties can continue the conversation.
- During a conference, the outside call can be placed on hold by pressing [**HOLD/INTERCOM**] on the handset or [**HOLD/CONF**] on the base unit. Internal communications are not suspended. Only the person who placed the call on hold can resume the full

conference by pressing [**Conf**] on the handset or [**HOLD/CONF**] on the base unit.

---

## Call share

This feature allows the base unit or the handset to join an existing outside call.

---

### To join a conversation (Call Share)

#### Using the handset

Press [**📞**] or [**📞**].

- “**Conference**” is displayed.

#### Using the base unit

Press [**SP-PHONE**].

## Guide to handset programming

For your reference, a chart of all programmable functions is printed below. Details for each item can be found on the corresponding pages. To program, press **[MENU]**, press **[▼]** or **[▲]** to scroll through the menu, and press **[Select]** when the desired menu item or setting is displayed.

### Important:

- Before programming, make sure the handset and base unit are not being used. The handset must be operated near the base unit and while off the base unit or charger.
- You can also program features using “direct commands”—special codes that take you directly to the feature you wish to program and allow you to select the desired setting (page 37).

### During programming:

- To exit programming, press **[OFF]** at any time.
- To go back to the previous menu, press **[Back]**.
- If you do not press any buttons for 60 seconds, the handset will exit programming mode.
- If the unit detects a problem, an error message will be displayed (page 60) and/or error beeps will sound.

Main menu	Sub-menu 1	Sub-menu 2	Page
Message play	—	—	50
Accessibility	Base Announce	Dial number	44
	HS Announce	Pre-Dial number	44
		Name List	44
	Hearing Aid Mode	—	44
Ringer setting	Ringer volume	—	39
	Ringer tone	—	39
	Incoming call.	—	40
Date and time	—	—	15
Talk Caller ID	—	—	41

## Programmable Settings

Main menu	Sub-menu 1	Sub-menu 2	Page
Initial setting	Set answering	Number of rings	54
		Recording time	54
		Remote code	54
		Recording mode	55
	Message alert	—	55
	LCD contrast	—	41
	Key tone	—	42
	Auto talk	—	43
	Caller ID edit	—	42
	Set tel line	Set dial mode	15
		Set flash time	43
		Set line mode	43
	Set base unit	Ringer tone	40
		Incoming call.	40
		Talk Caller ID	41
	Change language	—	14

---

## Programming via direct commands

You can also program features using “direct commands”—special codes that take you directly to the feature you wish to program and allow you to select the desired setting. There is no need to scroll through the unit’s menus.

Details of each feature can be found on the corresponding pages.

### Important:

- Before programming, make sure the handset and base unit are not being used. The handset must be operated near the base unit and while off the base unit or charger.

**1** Press **[MENU]**.

**2** Enter the desired feature code (page 37).

**3** Enter the desired setting code (page 37).

- This step may vary depending on the feature being programmed.

**4** Press **[Save]**.

**5** Press **[OFF]** to exit programming mode.

### Note:

- If you make a mistake or enter the wrong code, press **[OFF]** then start again by pressing **[MENU]**.

## Direct commands chart

### Important:

- The default settings are indicated by \*.

Feature	Feature code	Setting code	Page
Ringer volume	[1] [1]	[0] : Off [1] : Low [2] : Medium [3] : High*	39
Ringer tone (for handset)	[1] [2]	[1]–[3] : Tone pattern 1*–3 [4]–[7] : Melody pattern 1–4	39
Incoming call tone (for handset)	[1] [3]	[1] : On [2] : 2* [0] : Off	40
Message play	[2]	—	50
Date and time	[4]	Go to Step 3 on page 15.	15
Talking Keypad (for base unit)	[8] [1] [1]	[1] : On* [0] : Off	44
Talking Keypad (for handset)	[8] [2] [1]	[1] : On* [0] : Off	44
Name announcement	[8] [2] [2]	[1] : On* [0] : Off	44
Hearing aid mode	[8] [3]	[1] : Telecoil [0] : Off*	44
Talking Caller ID (for handset)	[9]	[1] : On* [0] : Off	41
LCD contrast	[0] [1]	[1]–[6] : Level 1–6 (Default=Level 3)	41
Key tone	[0] [2]	[1] : On* [0] : Off	42
Auto talk	[0] [3]	[1] : On [0] : Off*	43
Caller ID number auto edit	[0] [4]	[1] : On* [0] : Off	42
Dialing mode	[0] [5] [1]	[1] : Pulse [2] : Tone*	15
Flash time	[0] [5] [2]	[1] : 700 ms* [2] : 600 ms [3] : 400 ms [4] : 300 ms [5] : 250 ms [6] : 110 ms [7] : 100 ms [8] : 90 ms	43
Line mode	[0] [5] [3]	[1] : A [2] : B*	43
Number of rings	[0] [6] [1]	[2]–[7] : 2–7 rings [0] : Toll saver (Default=4 rings)	54
Recording time	[0] [6] [2]	[1] : 1 minute [2] : 2 minutes [3] : 3 minutes* [0] : Greeting only	54

## Programmable Settings

Feature	Feature code	Setting code	Page
Remote code	<b>[0] [6] [3]</b>	Go to Step 5 on page 54. (Default=11)	54
Recording mode	<b>[0] [6] [4]</b>	<b>[1]</b> : Standard recording* <b>[2]</b> : Enhanced recording	55
Change language	<b>[0] [8]</b>	<b>[1]</b> : English* <b>[2]</b> : Spanish	14
Message alert	<b>[0] [†]</b>	<b>[1]</b> : On <b>[0]</b> : Off*	55
Ringer tone (for base unit)	<b>[0] [*] [1]</b>	<b>[1]–[3]</b> :Tone pattern 1*-3 <b>[4]–[7]</b> :Melody pattern 1-4	40
Incoming call tone (for base unit)	<b>[0] [*] [2]</b>	<b>[1]</b> : On <b>[2]</b> : 2* <b>[0]</b> : Off	40
Talking Caller ID (for base unit)	<b>[0] [*] [4]</b>	<b>[1]</b> : On* <b>[0]</b> : Off	41

## Ringer settings

### Handset ringer volume

4 levels (high/medium/low/off) are available.

- 1 Press **[MENU]**.
- 2 Scroll to “Ringer setting” by pressing **[▼]** or **[▲]**, then press **[Select]**.
- 3 Press **[Select]** at “Ringer volume”.
- 4 Select the desired volume level by pressing **[▼]** or **[▲]**.
  - The volume will change and ring.
  - The number of steps indicates the volume level.
  - To turn the ringer off, press **[▼]** repeatedly until “off ?” is displayed.
- 5 Press **[Save]**.

#### Note:

- When the ringer volume is set to off, the handset will not ring for outside calls. The handset will ring at the low level for intercom calls.
- When the ringer volume is set to off, the handset will not announce caller names (page 27).
- If the handset ringer is turned off, “Ringer off” will be displayed while not in use. If the handset is off the base unit or charger when there are missed calls (page 28) or new messages (page 49), “Ringer off” is not displayed.
- You can adjust the ringer volume while an outside call is ringing. Press **[▼]** or **[▲]** while the handset is ringing.

### Temporary ringer off

While the handset is ringing for an outside call, you can turn the ringer off temporarily by pressing **[OFF]**. The handset will ring again as normal the next time a call is

received.

### Base unit ringer volume

To set the ringer volume to high (preset), medium, or low, press **VOLUME [▼]** or **[▲]**.

- To increase volume, press **VOLUME [▲]**. To decrease volume, press **VOLUME [▼]**.
- To stop ringing, press **[STOP]**.

To turn the ringer off, press and hold **VOLUME [▼]** until 2 beeps sound.

- “**RINGER OFF**” is displayed.

To turn the ringer on, press **VOLUME [▲]** or **[▼]**.

- The base unit will ring at low level.
- You can adjust the ringer volume while an outside call is ringing. Press **VOLUME [▼]** or **[▲]** while the base unit is ringing.

To turn the ringer off, press and hold

**VOLUME [▼]** for 2 beeps sound. “**RINGER OFF**” is displayed.

### Handset ringer tone

You can change the ringer tone heard when an outside call is received. There are 3 tones and 4 melodies.

#### Important:

- You cannot change the ringer tone for intercom calls.
- If you subscribe to a Distinctive Ring Service (such as IDENT-A-RING) from your telephone company with 2 or 3 consecutive rings, select a bell ringer pattern (Tone 1 to 3). If you select a melody pattern, you will not be able to distinguish lines by their ringers.
- If you select one of the melody ringer patterns, the ringer will continue to sound for several seconds if:
  - the caller hangs up before you answer the call, or

## Programmable Settings

---

- another person answers the call using another phone connected on the same line.

- 1 Press **[MENU]**.
  - 2 Scroll to “**Ringer setting**” by pressing **[▼]** or **[▲]**, then press **[Select]**.
  - 3 Scroll to “**Ringer tone**” by pressing **[▼]** or **[▲]**, then press **[Select]**.
  - 4 Select the desired ringer tone by pressing **[▼]** or **[▲]**.
    - The handset will ring and the ringer tone will change. If the handset ringer volume has been turned off, the handset will not ring.
    - You can also select the ringer tone by pressing **[1]** to **[7]**.
- 5 Press **[Save]**, then press **[OFF]**.
- 

### Base unit ringer tone

---

#### Using the base unit

**Make sure the base unit is not being used.**

Press **VOLUME [▼]** or **[▲]**, then select the desired ringer tone by pressing **[1]** to **[7]**.

**[1] to [3]** : Bell ringer patterns

**[4] to [7]** : Melody patterns

- After pressing **VOLUME [▼]** or **[▲]**, the base unit will ring using the current ringer tone.
  - The base unit will ring and the ringer tone will change.
  - To stop ringing, press **[STOP]**.
- 

#### Using the handset

- 1 Press **[MENU]**.
- 2 Scroll to “**Initial setting**” by pressing **[▼]** or **[▲]**, then press **[Select]**.

- 3 Scroll to “**Set base unit**” by pressing **[▼]** or **[▲]**, then press **[Select]**.

- 4 Press **[Select]** at “**Ringer tone**”.

- 5 Select the desired ringer tone by pressing **[▼]** or **[▲]**.
  - The base unit will ring and the ringer tone will change. If the base unit ringer volume has been turned off, the base unit will not ring (page 39).
  - You can also select the ringer tone by pressing **[1]** to **[7]**.

- 6 Press **[Save]**, then press **[OFF]**.
- 

### Handset incoming call tone

During an intercom call (page 32), you can be informed of incoming calls by two tones. If this feature is turned on, incoming call tones will be heard for as long as the line is ringing. If this feature is set to “2”, incoming call tones will be heard only 2 times.

If this feature is turned off, no tones will be heard.

- 1 Press **[MENU]**.
  - 2 Scroll to “**Ringer setting**” by pressing **[▼]** or **[▲]**, then press **[Select]**.
  - 3 Scroll to “**Incoming call.**” by pressing **[▼]** or **[▲]**, then press **[Select]**.
  - 4 Select “**on**”, “**off**” or “**2**” by pressing **[▼]** or **[▲]**.
  - 5 Press **[Save]**, then press **[OFF]**.
- 

### Base unit incoming call tone

- 1 Press **[MENU]**.
- 2 Scroll to “**Initial setting**” by pressing **[▼]** or **[▲]**, then press **[Select]**.



- 3** Scroll to “**Set base unit**” by pressing [**▼**] or [**▲**], then press [**Select**].
- 4** Scroll to “**Incoming call.**” by pressing [**▼**] or [**▲**], then press [**Select**].
- 5** Select “**on**”, “**off**” or “**2**” by pressing [**▼**] or [**▲**].
- 6** Press [**Save**], then press [**OFF**].

---

---

## Display setting

---

### Handset LCD contrast

You can adjust the handset display contrast. There are 6 levels.

- 1** Press [**MENU**].
- 2** Scroll to “**Initial setting**” by pressing [**▼**] or [**▲**], then press [**Select**].
- 3** Scroll to “**LCD contrast**” by pressing [**▼**] or [**▲**], then press [**Select**].
- 4** Select the desired contrast by pressing [**▼**] or [**▲**].
  - The contrast will change.
- 5** Press [**Save**], then press [**OFF**].

---

---

## Functions

---

### Handset Talking Caller ID

You can turn the Talking Caller ID feature (page 27) on or off for the handset.

- 1** Press [**MENU**].
- 2** Scroll to “**Talk Caller ID**” by pressing [**▼**] or [**▲**], then press [**Select**].
- 3** Select “**off**” or “**on**” by pressing [**▼**] or [**▲**].
- 4** Press [**Save**], then press [**OFF**].

---

### Base unit Talking Caller ID

You can turn the Talking Caller ID feature (page 27) on or off for the base unit. This feature must be set by using the handset.

- 1** Press [**MENU**].

## Programmable Settings

---

- 2 Scroll to “**Initial setting**” by pressing **[▼]** or **[▲]**, then press **[Select]**.
- 3 Scroll to “**Set base unit**” by pressing **[▼]** or **[▲]**, then press **[Select]**.
- 4 Scroll to “**Talk Caller ID**” by pressing **[▼]** or **[▲]**, then press **[Select]**.
- 5 Select “**off**” or “**on**” by pressing **[▼]** or **[▲]**.
- 6 Press **[Save]**, then press **[OFF]**.

---

## Initial setting

---

### Caller ID edit

---

#### Using the handset

You can turn the Caller ID number auto edit feature (page 30) on or off.

- 1 Press **[MENU]**.
  - 2 Scroll to “**Initial setting**” by pressing **[▼]** or **[▲]**, then press **[Select]**.
  - 3 Scroll to “**Caller ID edit**” by pressing **[▼]** or **[▲]**, then press **[Select]**.
  - 4 Select “**off**” or “**on**” by pressing **[▼]** or **[▲]**.
  - 5 Press **[Save]**, then press **[OFF]**.
- If you fail to reach your destination when making a call, the phone number you dialed might have an incorrect pattern. Edit the phone number with another pattern (page 30).
  - When this feature is turned off, the unit will still be able to display Caller ID, but incoming Caller ID numbers will not be automatically edited.

---

### Handset key tone

You can select whether or not key tones are heard when keys are pressed. Includes confirmation tones and error tones.

- 1 Press **[MENU]**.
- 2 Scroll to “**Initial setting**” by pressing **[▼]** or **[▲]**, then press **[Select]**.
- 3 Scroll to “**key tone**” by pressing **[▼]** or **[▲]**, then press **[Select]**.

**4** Select "Off" or "On" by pressing [▼] or [▲].

**5** Press [Save], then press [OFF].

---

### Auto talk

When this feature is turned on, you can answer a call by lifting the handset off the base unit or charger without pressing [📞] or [📞].

**1** Press [MENU].

**2** Scroll to "Initial setting" by pressing [▼] or [▲], then press [Select].

**3** Scroll to "Auto talk" by pressing [▼] or [▲], then press [Select].

**4** Select "On" or "Off" by pressing [▼] or [▲].

**5** Press [Save], then press [OFF].

#### Note:

- If you subscribe to Caller ID service and want to view the caller's information on the handset display after lifting up the handset to answer a call, turn off this feature.

---

### Flash time

#### Using the handset

The flash time depends on your telephone exchange or host PBX.

You can select: "90ms" (milliseconds), "100ms", "110ms", "250ms", "300ms", "400ms", "600ms", or "700ms".

**1** Press [MENU].

**2** Scroll to "Initial setting" by pressing [▼] or [▲], then press [Select].

**3** Scroll to "Set tel line" by pressing [▼] or [▲], then press [Select].

**4** Scroll to "Set flash time" by pressing [▼] or [▲], then press [Select].

**5** Select the desired time by pressing [▼] or [▲].

**6** Press [Save], then press [OFF].

#### Note:

- The setting should stay at 700 ms unless pressing [FLASH/CALL WAIT] fails to pick up the Call Waiting call.
- If PBX functions do not work correctly, consult your PBX supplier for the correct settings.

---

### Line mode

If "Line in use" on the handset and "**LINE IN USE**" on the base unit are not displayed properly, the line mode selection is incorrect. Set line mode to "A".

**1** Press [MENU].

**2** Scroll to "Initial setting" by pressing [▼] or [▲], then press [Select].

**3** Scroll to "Set tel line" by pressing [▼] or [▲], then press [Select].

**4** Scroll to "Set line mode" by pressing [▼] or [▲], then press [Select].

**5** Select "A" or "B" by pressing [▼] or [▲].

**6** Press [Save], then press [OFF].

### Accessibility

---

#### Talking Keypad

Talking Keypad is a feature that announces phone numbers that you dial, allowing you to confirm dialed numbers audibly before making calls. You can turn this feature on or off for the handset and base unit separately.

While handset Talking Keypad is turned on, the handset announces each dialing button you press when pre-dialing (page 16).

While base unit Talking Keypad is turned on, the base unit announces each dialing button you press, and announces "Redial" when [REDIAL] is pressed (page 19).

**If you dial a phone number quickly, the handset and base unit may not announce the dialed phone number correctly. For best results, dial each digit one at a time, and wait for the unit to announce each digit before dialing the next digit.**

---

#### Handset Talking Keypad

- 1 Press [MENU].
- 2 Scroll to "Accessibility" by pressing [▼] or [▲], then press [Select].
- 3 Scroll to "HS Announce" by pressing [▼] or [▲], then press [Select].
- 4 Press [Select] at "Pre-Dial number".
- 5 Select "Off" or "On" by pressing [▼] or [▲].
- 6 Press [Save], then press [OFF].

---

#### Base unit Talking Keypad

- 1 Press [MENU].

- 2 Scroll to "Accessibility" by pressing [▼] or [▲], then press [Select].
- 3 Press [Select] at "Base Announce".
- 4 Press [Select] at "Dial number".
- 5 Select "Off" or "On" by pressing [▼] or [▲].
- 6 Press [Save], then press [OFF].

---

#### Handset Name Announcement

Name Announcement is a feature that announces names or phone numbers shown on the display while you are using the handset to search the phonebook, caller list, redial list, and one-touch dialer, allowing you to confirm displayed items audibly before making calls.

You can turn this feature on or off for the handset.

- 1 Press [MENU].
- 2 Scroll to "Accessibility" by pressing [▼] or [▲], then press [Select].
- 3 Scroll to "HS Announce" by pressing [▼] or [▲], then press [Select].
- 4 Scroll to "Name List" by pressing [▼] or [▲], then press [Select].
- 5 Select "Off" or "On" by pressing [▼] or [▲].
- 6 Press [Save], then press [OFF].

---

#### Handset Telecoil Hearing Aid Mode

Hearing Aid Mode is a feature that reduces the noise often experienced by "Telecoil" hearing aid users when using a digital cordless telephone.

To turn this feature on, follow the steps below and select "Telecoil".

- 1 Press [MENU].

- 2** Scroll to “**Accessibility**” by pressing [**▼**] or [**▲**], then press [**Select**].
- 3** Scroll to “**Hearing Aid Mode**” by pressing [**▼**] or [**▲**], then press [**Select**].
- 4** Select “**Telecoil**” or “**Off**” by pressing [**▼**] or [**▲**].
- 5** Press [**Save**], then press [**OFF**].

**Note:**

- When “Telecoil” is selected, “[**HA**]” is displayed after you press [**↶**].

Talk 00-00-32	[ <b>HA</b> ]
------------------	---------------

- If “Telecoil” is selected, the battery operating time will be shortened (page 10).
- If “Telecoil” is selected, the cordless handset receiver may feel warm during use. This is normal.

**Re-registering the handset**

If “**No link to base. Move closer to base, try again.**” is displayed even when the handset is near the base unit, you may need to re-register the handset to the base unit.

**Important:**

- Make sure the base unit is not being used.
- Have the handset and base unit near each other when re-registering the handset.
- Follow steps 1 and 2 listed below. You have about 1 minute to complete them.

**1 Base unit:**

Press and hold [**LOCATOR/INTERCOM**] until a beep sounds.

- The CHARGE indicator flashes.

**2 Handset:**

Press and hold [**FLASH/CALL WAIT**] until “**Handset Registering**” is displayed.

- When registration is complete, a beep sounds from the handset.
- **Wait for 20 seconds after registration is complete while the handset establishes communication with the base unit.**

**Note:**

- If the handset beeps 3 times and “**Error!!**” is displayed, an error occurred. Try again from step 1.
- You can stop registration by pressing [**OFF**] on the handset, and pressing [**LOCATOR/INTERCOM**] on the base unit.

### Answering system

The unit contains an answering system which can answer and record calls for you when you are unavailable to answer the phone.

For details about memory capacity, see page 52.

#### Important:

- Only 1 person can access the answering system (listen to messages, record a greeting message, etc.) at a time.
- When callers leave messages, the unit records the day and time of each message. Make sure the date and time have been set (page 15).
- You can select the caller's recording time (page 54).

### Recording your greeting message

You can record your own greeting message (max. 2 minutes) that will be played when the answering system answers a call. If you do not record a greeting message, a pre-recorded greeting message will be used.

**Sample greeting message:** "Hello, this is (your name and/or number). Sorry, I cannot take your call. Please leave a message after the beep. Thank you."

[GREETING CHECK]

[GREETING REC] [ERASE]  
[STOP]

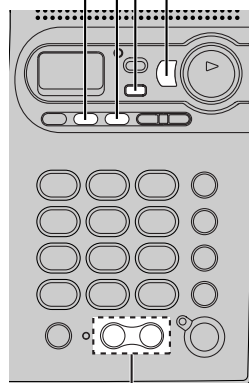

VOLUME [V], [^] MIC

- 1** Press [GREETING REC].
  - The unit announces "To record greeting, press Record again."
- 2** Within 10 seconds, press [GREETING REC] again.
- 3** After the unit beeps, speak clearly about 20 cm (8 inches) away from the MIC.
  - The display will show the elapsed recording time.
  - If you record for over 2 minutes, the unit will stop recording.

### 4 To stop recording, press **[GREETING REC]** or **[STOP]**.

- To change the greeting, start again from step 1.

#### Note:

- You can use the enhanced recording mode for clearer sound, if necessary (p. 55).
- If “E” is displayed, 6 beeps sound and “Your greeting was not recorded. Record your greeting again.” is announced, start again from step 1.
- To adjust the speaker volume, press **VOLUME [V]** or **[^]** during playback.
- 9 levels (0–8) are available while using the Answering System. The level is displayed on the base unit.

### To play back the greeting message

Press **[GREETING CHECK]**.

### Erasing your greeting message

Press **[GREETING CHECK]**, and then press **[ERASE]** while your greeting message is playing.

- If you do not re-record your greeting message, the unit will use a pre-recorded greeting message.

### Pre-recorded greeting message

If you do not record a greeting message, one of 2 pre-recorded messages will be played when a call is received depending on the caller's recording time (page 54).

- When the recording time is set to “1min”, “2min”, or “3min”:  
“Hello, we are not available now. Please leave your name and phone number after the beep. We will return your call.”
- If recording time runs out, the unit will automatically switch to the “Greeting only” mode, and no new messages will be recorded.
- When the recording time is set to “Greeting only”:

“Hello, we are not available now. Please call again. Thank you for your call.”

To play back the pre-recorded greeting, press **[GREETING CHECK]**.

## Turning the answering system on/off

### Using the base unit

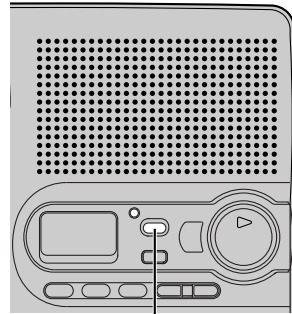

**[ANSWER ON]** and Indicator

Press **[ANSWER ON]**.

- When the answering system is turned on, the ANSWER ON indicator lights and the unit announces “Answer set” and the day and time. If “Answer set. Set time” is heard, set the date and time (page 15).
  - When the answering system is turned off, the ANSWER ON indicator turns off and the unit announces “Answer off”.
- To turn off the Answering System, press **[ANSWER ON]**.

### Using the handset

- 1 Press **[MENU]**.
- 2 Press **[Select]** at “Message play”.
- 3 Press **[8]** to turn on the Answering System.
  - “Answer set” is heard.

## Answering System Features

### 4 Press [OFF].

- To turn the Answering System off, press [0] in step 3. "Answer off" is heard.

### Screening your calls

While a caller is leaving a message, you can listen to the call through the base unit's speaker. To adjust the speaker volume, press **VOLUME** [∧] or **VOLUME** [∨] repeatedly.

You can answer the call by pressing [↶] or [↷].

### To turn off the call screening feature

When the base unit is not in use, press [GREETING CHECK], then press **VOLUME** [∨] repeatedly until "0" is displayed.

OR

While screening, press **VOLUME** [∨] repeatedly until "0" is displayed.

#### Note:

- If the incoming call monitoring feature is turned off, it will remain off when the next call is monitored.
- If you adjust the speaker volume while playing back messages or using the speakerphone, the speaker volume for monitoring will be turned on again. To turn the speaker volume off, see "To turn off the call screening feature" of above step.

## Listening to messages

When new messages have been recorded:

- The NEW MESSAGE indicator on the base unit will flash.
- The Ringer/Message Alert indicator on the handset will flash slowly if the message alert feature is turned on (page 55).

The base unit display will show the number of messages (old and new) recorded by the answering system.

Example: The total number of recorded messages is 10.

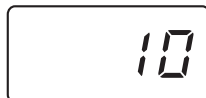

## Listening to messages using the base unit

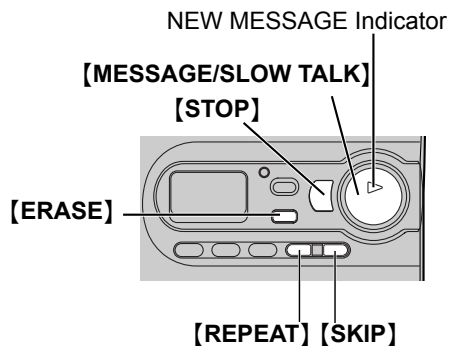

Press [MESSAGE/SLOW TALK].

- The unit will announce the number of new messages and will play back the new messages.
- When you have no new messages, the unit will announce "No new messages. All message playback", and will play back all messages.



### Note:

- The display shows the message number during playback.
- During playback, the unit will announce the day and time that each message was recorded. (**Voice time/day stamp**)
- At the end of the last message, the unit announces “*End of final message*”.
- If a call is received during playback, the unit rings and playback stops. To answer the call, press **[SP-PHONE]**. For playback, start again from the beginning after hanging up.

### To adjust the speaker volume

9 levels (high to off) are available. Press **VOLUME [^]** or **VOLUME [v]** repeatedly while using the answering system.

### To slow down the playback speed (Slow Talk Message Playback)

Press **[MESSAGE/SLOW TALK]** during playback.

- To return to normal speed, press **[MESSAGE/SLOW TALK]** on the base unit.
- Each time you press the button during playback, the speed will change to slow/normal.
- Playback speed will return to normal after you finish listening to messages.

### Repeating a message

Press **[REPEAT]** while listening to the message.

- If pressed within the first 5 seconds of a message, the previous message will be played.

### Skipping a message

Press **[SKIP]** to play the next message.

### Stopping message playback

Press **[STOP]**.

- To resume playback, press **[MESSAGE/SLOW TALK]**.
- If you do not press any button for 60 seconds or if you press **[STOP]** again, playback mode will be canceled.

### Erasing a specific message

Press **[ERASE]** while listening to the message you want to erase.

- The unit beeps, then plays back the next message.
- To exit playback mode, press **[STOP]** twice.

### Erasing all messages

**1** Press **[ERASE]** while the base unit is not being used.

- The unit will announce “*To erase all messages, press ERASE again.*”

**2** Within 10 seconds, press **[ERASE]** again.

- The unit will announce “*No messages.*”

### Note:

- Caller information for the erased messages will remain in the caller list.

### Listening to messages using the handset (Remote Operation)

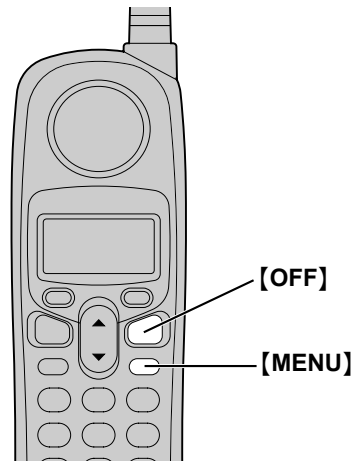

## Answering System Features

---

If “**New message**” is displayed on the handset, new messages have been recorded.

- If the Message Alert is turned on (page 55), the Ringer/Message Alert indicator on the handset will flash slowly when new messages have been recorded and the handset is not in use.

**1** Press **[MENU]**.

**2** Press **[Select]** at “**Message play**”.

- The unit announces the number of new messages and only new messages are played back from the speaker. To switch to the receiver, press **[↶]**. To switch back to the speaker, press **[↷]**.
- When you have no new messages, the unit announces “*No new messages. All message playback*” and plays back all messages.
- When you have no messages, the unit announces “*No messages*”.
- If you do not press any button, the voice guidance will start.

**3** Press **[OFF]** when finished.

### Note:

- If a call is received during playback, the unit rings and playback stops. To answer the call, press **[↶]** or **[↷]**. For playback, start again from the beginning after hanging up.
- At the end of the last message, “*End of final message*” is heard. The unit will announce the remaining recording time if it is less than 3 minutes.
- If you hear “*Memory full*” after playback, erase unnecessary messages (page 49).
- When memo messages are played (p. 51), “**MEMO**” is displayed.

---

### To slow down the playback speed (Slow Talk Message Playback)

Press **[3]** during playback.

- To return to normal speed, press **[3]** on the handset.
- Each time you press the button during playback, the speed will change to slow/normal.
- Playback speed will return to normal after you finish listening to messages.

---

### Repeating a message

Press **[Repeat]** while listening to the message.

- If pushed within the first 5 seconds of a message, the previous message will be played.

---

### Skipping a message

Press **[Skip]** to play the next message.

---

### Voice guidance

If you do not press any buttons after the last message is played back, the unit’s voice guidance starts. Operate the answering system by following the guidance as necessary.

The unit will announce “*Press 4 to play back new messages. Press 5 to play back all messages.*”

- You can press buttons for other playback options (page 51) even if the voice guidance has started.
- If you do not press any button within 10 seconds after the voice guidance, the handset returns to standby mode.

### Answering system commands

You can also operate the answering system by pressing dial keys.

To use the following commands, press **[MENU]**, then select "Message play".

Key	Command
<b>[1]</b> or <b>[Repeat]</b>	Repeat message (during playback) <sup>*1</sup>
<b>[2]</b> or <b>[Skip]</b>	Skip message (during playback)
<b>[3]</b>	Change the playback speed to slow/normal
<b>[4]</b>	Play new messages
<b>[5]</b>	Play all messages
<b>[8]</b>	Turn answering system on
<b>[9]</b>	Stop playback <sup>*2</sup>
<b>[0]</b>	Turn answering system off
<b>[*][4]</b>	Erase this message (during playback)
<b>[*][5]</b>	Erase all messages

\*1 If pressed within the first 5 seconds of a message, the previous message will be played.

\*2 To resume operation, press a command key within 15 seconds, or the voice guidance will start.

### Calling back (Caller ID subscribers only)

If Caller ID information was received for the call, you can call the caller back while listening to a message.

**To call back the displayed number:**

- 1** During playback, press **[MENU]**.
- 2** Press **[Call]**, **[↶]** or **[📞]**.
  - The unit stops playback and dials the phone number.
  - If you need to edit the phone number to call back, see page 30.

## Recording a memo message

NEW MESSAGE Indicator

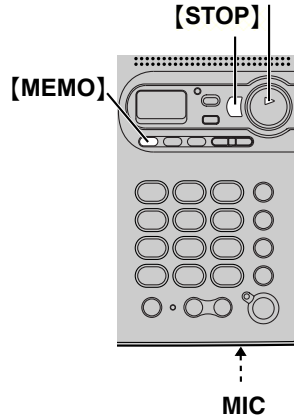

You can record a voice memo message of up to 3 minutes in memory.

- 1** Press **[MEMO]**.
- 2** After the long beep, talk clearly, about 20 cm (8 inches) away from the **MIC**.
  - The base unit display shows the elapsed recording time.
  - If the elapsed recording time exceeds 99 seconds, the counter continues from 00 to indicate 100 seconds.
- 3** When finished, press **[MEMO]** or **[STOP]**.
  - The NEW MESSAGE indicator flashes.
  - If you record for over 3 minutes in step 2, the unit will stop recording.
  - If "E" is displayed, 6 beeps sound and "Your message was not recorded. Record your message again." is announced, start again from step 1.

### Memory capacity

The total recording capacity (including your greeting message, caller messages and memo) is about 16 minutes (about 8 minutes in “Enhanced recording mode”, see page 55). A maximum of 64 messages (including a greeting message and memo message) can be recorded.

- If message memory becomes full:
  - **FULL** flashes on the base unit.
  - the ANSWER ON indicator flashes rapidly (if the answering system is turned on).
  - the unit announces “*Memory full*” when operating the answering system and recording a memo message. To record additional messages, erase unnecessary messages.
- If less than 3 minutes of recording time is available, the unit will announce the remaining recording time when operating the answering system.
- Messages are retained even if a power failure occurs. All messages are saved until you erase them. (**Flash memory message backup**)
- The total recording capacity may be reduced by the calling party’s background noise.

#### Note:

- If message memory becomes full, the unit will automatically switch to the “**Greeting only**” mode. New messages will not be recorded. If you have recorded your own greeting message, that same greeting message will be announced to callers even though their messages will not be recorded. If you have not recorded your own greeting message, the pre-recorded message used for “**Greeting only**” mode will be announced to callers (page 47).

### Remote operation

Using a touch tone phone, you can call your phone number from outside and access the unit to listen to messages. The unit’s voice guidance will prompt you to press certain dial keys to perform different operations.

#### Important:

- In order to operate the answering system remotely, you must first set a remote code (page 54). This code must be entered each time you operate the answering system remotely.

### Using the answering system remotely

- 1 Dial your phone number from a touch tone phone.
  - If the ring count is set to “**To11 saver**” (page 54), the number of rings you hear will indicate whether or not you have new messages.
- 2 After the greeting message starts, enter your remote code.
  - The unit will announce the number of new messages, and will play back the new messages.
- 3 After 3 seconds, the voice guidance will start. Follow the voice guidance as necessary.
- 4 When finished, hang up.

#### Note:

- When you press a key, press firmly.
- You can hang up at any time.
- You can ignore the voice guidance and control the unit using remote commands.

### Voice guidance

During remote operation, the unit's voice guidance will prompt you to press **[1]** to perform a specific operation, or press **[2]** to listen to more available operations. Operations are presented by voice guidance in the following order:

- Play back all messages
- Play back new messages
- Record a message
- Erase all messages
- Record your greeting message

#### Note:

- If you do not press any dial keys within 10 seconds after a voice guidance prompt, the unit will announce, "Thank you for your call" then disconnect your call.
- If less than 3 minutes of recording time is available, the unit will announce the remaining recording time after the last message is played back.
- If the unit announces "Memory full", erase unnecessary messages.

### Remote commands

You can press dial keys to access certain answering system functions without waiting for the voice guidance to prompt you.

Key	Remote command
<b>[1]</b>	Repeat message (during playback) <sup>*1</sup>
<b>[2]</b>	Skip message (during playback)
<b>[3]</b>	Change the playback speed to slow/normal.
<b>[4]</b>	Play new messages
<b>[5]</b>	Play all messages
<b>[7]</b>	Record a greeting message
<b>[9]</b>	Stop (recording, playback) <sup>*2</sup>
<b>[0]</b>	Turn answering system off
<b>[*][4]</b>	Erase this message (during playback)
<b>[*][5]</b>	Erase all messages

\*1 If pushed within the first 5 seconds of a message, the previous message will be played.

\*2 To resume operation, enter a remote command within 15 seconds, or the voice guidance will start.

### Turning on the answering system remotely

If the answering system is off, you can turn it on remotely.

- 1** Dial your phone number.
- 2** Let the phone ring 15 times.
  - The unit will answer your call with the greeting message.
  - You can hang up, or if you call from a touch tone phone, you can enter your remote code and begin remote operation (page 52).

## Answering System Features

---

### Skipping the greeting message to leave a message

You can leave a message just as any outside caller can. Call your phone number, then press **[\*]** to skip the greeting message and record your message after the beep.

---

## Answering system settings

---

### Remote code

A remote code must be entered when operating the answering system remotely. This code prevents unauthorized parties from listening to your messages remotely. Store any 2-digit number (00–99).

- 1 Press **[MENU]**.
- 2 Scroll to “**Initial setting**” by pressing **[▼]** or **[▲]**, then press **[Select]**.
- 3 Press **[Select]** at “**Set answering**”.
- 4 Scroll to “**Remote code**” by pressing **[▼]** or **[▲]**, then press **[Select]**.
- 5 Enter a **2-digit remote code (00-99)**.
- 6 Press **[Save]**, then press **[OFF]**.

#### Note:

- To confirm the remote code, repeat steps 1 to 4. Press **[OFF]** when finished.

### Caller’s recording time

You can change the maximum message recording time.

“**1min**”, “**2min**”, or “**3min**”: Caller messages are limited to 1 minute to 3 minutes.

“**Greeting only**”: The unit plays the greeting message but does not record caller messages.

- 1 Press **[MENU]**.
- 2 Scroll to “**Initial setting**” by pressing **[▼]** or **[▲]**, then press **[Select]**.
- 3 Press **[Select]** at “**Set answering**”.
- 4 Scroll to “**Recording time**” by pressing **[▼]** or **[▲]**, then press **[Select]**.
- 5 Select the recording time by pressing **[▼]** or **[▲]**.
  - You can also select the recording time by pressing **[1]**, **[2]**, **[3]** or **[0]** (Greeting only).
- 6 Press **[Save]**, then press **[OFF]**.

If you select “**Greeting only**”, the unit will answer calls with the greeting message, and then hang up. The unit will not record any incoming messages. The base unit will display “**00**” instead of the number of messages.

---

### Number of rings

You can select the number of times the unit rings before the Answering System answers a call, from “**2**” to “**7**” or “**Toll saver**”\*.

- 1 Press **[MENU]**.
- 2 Scroll to “**Initial setting**” by pressing **[▼]** or **[▲]**, then press **[Select]**.
- 3 Press **[Select]** at “**Set answering**”.

- 4 Press **[Select]** at “Number of rings”.
- 5 Select the number of rings by pressing **[▼]** or **[▲]**.
  - You can also select the number of rings by pressing **[0]** (Toll saver\*), or **[2]** to **[7]**.
- 6 Press **[Save]**, then press **[OFF]**.

### \*Toll saver

When you call the unit from a remote operation, the number of rings will tell you if there are any new messages. If the unit answers on the 2nd ring, there is at least one new message. If the unit answers on the 4th ring, there are no new messages. To save the toll charges for the call, hang up immediately when you hear the 3rd ring. The 3rd ring indicates that there are no new messages.

## Recording mode

Two recording modes are available. The factory preset is “Standard recording (16min)”, which provides more recording time (16 min) and standard sound quality. “Enhanced recording (8 min)” provides less recording time (8 min) but clearer sound quality.

- 1 Press **[MENU]**.
- 2 Scroll to “Initial setting” by pressing **[▼]** or **[▲]**, then press **[Select]**.
- 3 Press **[Select]** at “Set answering”.
- 4 Scroll to “Recording mode” by pressing **[▼]** or **[▲]**, then press **[Select]**.
- 5 Select the recording mode by pressing **[▼]** or **[▲]**.
  - You can also select the recording mode by pressing **[1]** (Standard) or **[2]** (Enhanced).

- 6 Press **[Save]**, then press **[OFF]**.

## Message alert

You can select whether or not the Ringer/Message Alert indicator on the handset will flash when new messages have been recorded (page 48).

- 1 Press **[MENU]**.
- 2 Scroll to “Initial setting” by pressing **[▼]** or **[▲]**, then press **[Select]**.
- 3 Scroll to “Message alert” by pressing **[▼]** or **[▲]**, then press **[Select]**.
- 4 Select “on” or “off” by pressing **[▼]** or **[▲]**.
- 5 Press **[Save]**, then press **[OFF]**.

### Note:

- The Ringer/Message Alert indicator will not flash for new messages while the handset is in use.
- The Ringer/Message Alert indicator acts both as a ringer indicator and as a message alert indicator. This indicator will flash rapidly when a call is received whether this feature is on or off.
- Battery operating time will be shortened when using this feature (page 10).

## Wall mounting

The base unit can be mounted on a wall phone plate.

- 1 Push the hook and turn it upward. Turn the hook until a click is heard.

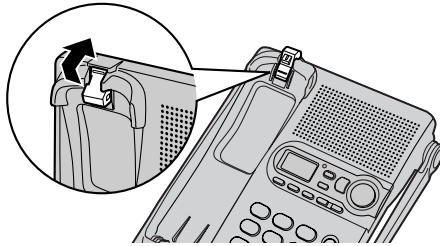

- 2 Press the tabs in the direction of the arrows (①), then remove the wall mounting adaptor (②).

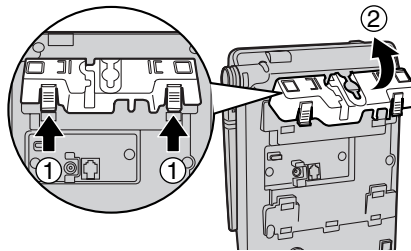

- 3 Connect the AC adaptor. Tuck the telephone line cord inside the wall mounting adaptor, then push the adaptor in the direction of the arrows (① and ②).
  - The word "UP WALL" should face upward.
  - Fasten the AC adaptor cord to prevent it from being disconnected.

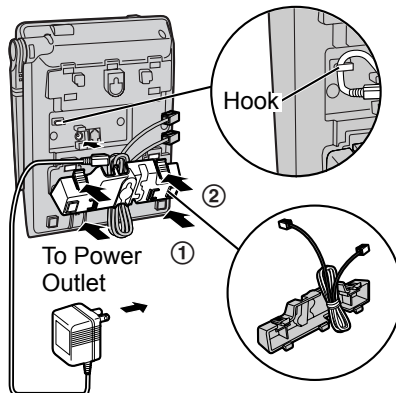



- 4** Connect the telephone line cord. Mount the unit, then slide it down.
- Raise the antenna.

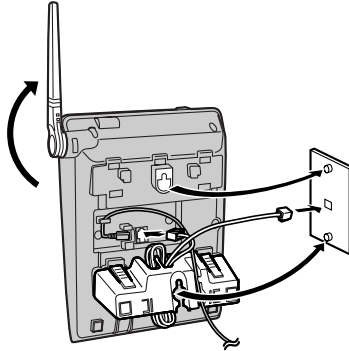

**5 To charge the handset battery:**

Rest the handset on the charge contacts (①), then push the top of the handset so the hook snaps into the slot at the top of the handset (②).

- The CHARGE indicator lights and the unit beeps once.

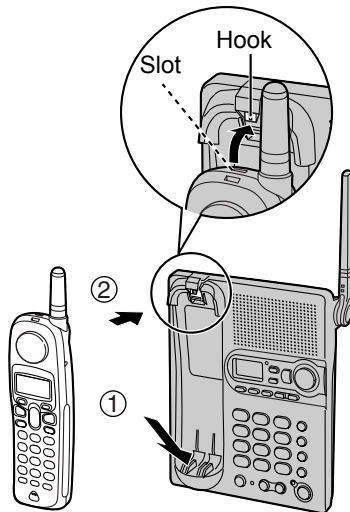

## Useful Information

### Charger unit

The charger can be wall mounted, as shown below.

- 1 Connect the AC adaptor.
  - 2 Drive the screws (not included) into the wall using the wall template (see below).
  - 3 Mount the charger (①).
  - 4 Slide it down (②) and to the right (③) until it is secured.
- If the charger is wall mounted, remove the shoulder rest attachment to place the handset into the charger.

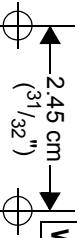
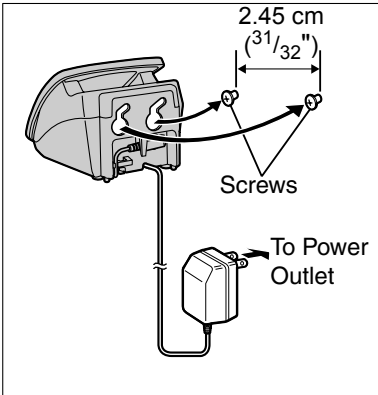

Wall mount template for the charger

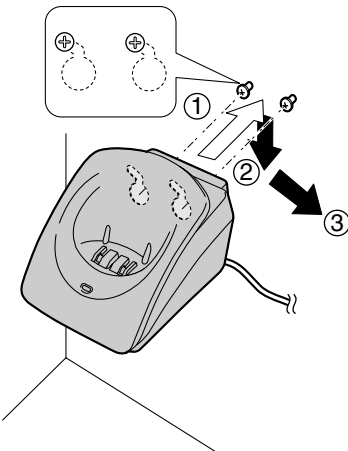

### Belt clip

You can hang the handset on your belt or pocket using the included belt clip.

#### To attach the belt clip

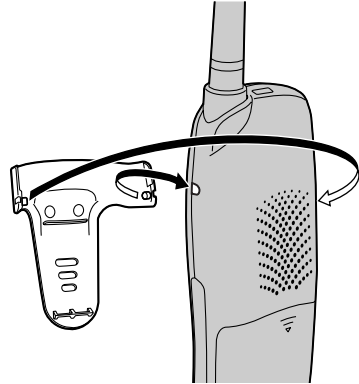

#### To remove the belt clip

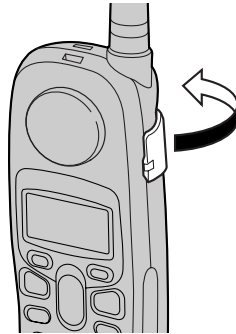

## Shoulder Rest Attachment

Use the shoulder rest attachment if you need to keep your hands free during a phone conversation.

If you use the shoulder rest attachment, you will need to use the charger unit for charging the battery.

### To attach the shoulder rest attachment

Attach the included belt clip to the handset (see "Belt Clip"), then attach the shoulder rest attachment to the belt clip as shown below. You will hear a click when the shoulder rest attachment is in place.

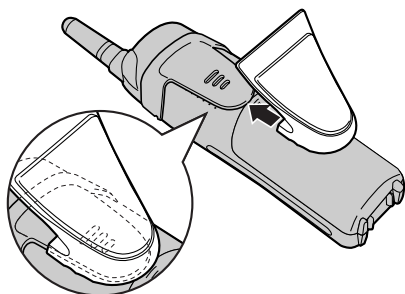

### To remove the shoulder rest attachment

Slide the base of the attachment in the direction of the arrow as shown below.

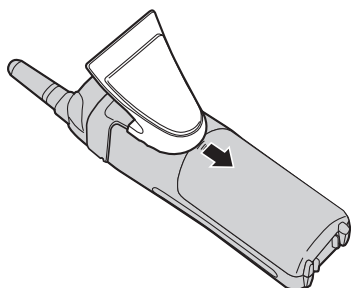

## Headset (optional)

Connecting an optional headset to the handset allows hands-free phone conversations. Please use only a Panasonic headset. See page 4 for compatible headsets and ordering information.

### To connect an optional headset to the handset

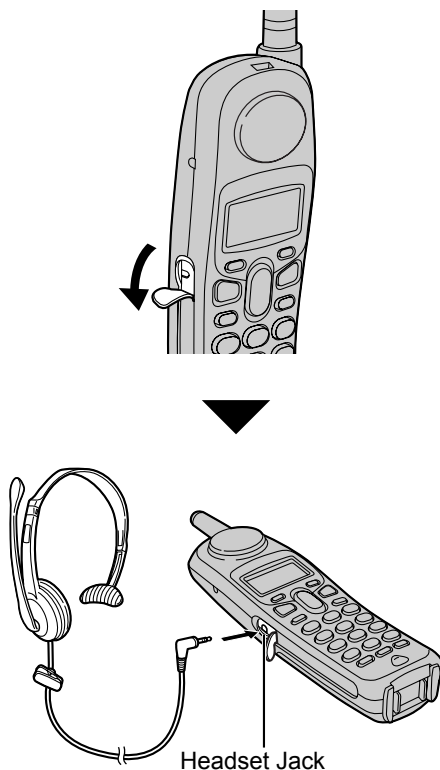

- Model shown is KX-TCA86.

### Note:

- To switch to the speakerphone, press . To return to the headset, press .



## **If the Following Appear on Your Display...**

The following will be displayed when the unit needs your attention.

<b>Display message</b>	<b>Cause &amp; Remedy</b>
<b>Recharge battery</b>	<ul style="list-style-type: none"><li>● The battery needs to be charged. Recharge the battery (page 10).</li></ul>
<b>Charge for 6h</b>	<ul style="list-style-type: none"><li>● The battery has been discharged. The handset will not work. Fully charge the battery (page 10).</li></ul>
<b>No link to base. Move closer to base, try again.</b>	<ul style="list-style-type: none"><li>● The handset has lost communication with the base unit. Walk closer to the base unit and try again or re-register the handset (page 45).</li><li>● Confirm the base unit's AC adaptor is plugged in.</li><li>● Raise the base unit antenna.</li></ul>
<b>Please lift up and try again.</b>	<ul style="list-style-type: none"><li>● A handset button was pressed while the handset was on the base unit or charger. Lift the handset and press the button again.</li></ul>
<b>Busy</b>	<ul style="list-style-type: none"><li>● The base unit is in use. Try again later.</li></ul>
<b>Error!!</b>	<ul style="list-style-type: none"><li>● When you tried to re-register the handset, the handset and base unit could not link for some reason, such as interference from electrical appliances. Move the handset and base unit away from any electrical appliances and try again.</li></ul>
<b>Phone book full</b>	<ul style="list-style-type: none"><li>● When you tried to store an item in the phonebook, the phonebook memory was full. Press <b>[OFF]</b> to exit the programming mode. To erase other items from the phonebook, see page 24.</li></ul>
<b>System is busy. Please try again later.</b>	<ul style="list-style-type: none"><li>● The handset has lost communication with the base unit. Walk closer to the base unit and try again.</li><li>● The Answering System is in use, such as answering a call or playing back messages. Try again later.</li></ul>
<b>Line in use</b>	<ul style="list-style-type: none"><li>● The base unit is conducting an outside call or another phone on the same telephone line is in use.</li></ul>
<b>Line on hold</b>	<ul style="list-style-type: none"><li>● The base unit is on hold for an outside call.</li></ul>

## Troubleshooting

If the handset display shows error messages, see “If the Following Appear on Your Display...” (p. 60) for the Cause & Remedy.

Problem	Cause & Remedy
<p>“No link to base. Move closer to base, try again.” is displayed and an alarm tone sounds.</p>	<ul style="list-style-type: none"> <li>● You are too far from the base unit. Walk closer to the base unit.</li> <li>● Confirm the base unit’s AC adaptor is plugged in.</li> <li>● Raise the base unit antenna.</li> <li>● If the above remedies do not solve the problem, the handset may have lost communication with the base unit. Register the handset again (page 45).</li> </ul>
<p>Static, sound cuts in/out, fades. Interference from other electrical units.</p>	<ul style="list-style-type: none"> <li>● Move the handset and base unit away from other electrical appliances.</li> <li>● Walk closer to the base unit.</li> <li>● Raise the base unit antenna.</li> <li>● If your unit is connected to a telephone line with DSL service, we recommend connecting a noise filter between the base unit and the telephone line jack. Contact your DSL provider for details.</li> </ul>
<p>The handset and/or base unit does not ring.</p>	<ul style="list-style-type: none"> <li>● The ringer volume is turned off. Set to high, medium, or low (page 39).</li> </ul>
<p>The handset display is blank.</p>	<ul style="list-style-type: none"> <li>● If the handset display is blank, fully charge the battery (page 10).</li> </ul>
<p>You cannot program any function items.</p>	<ul style="list-style-type: none"> <li>● Programming is not possible while the handset and/or base unit is being used.</li> <li>● Do not pause for over 60 seconds while programming.</li> <li>● Walk closer to the base unit.</li> <li>● While another user is listening to messages or the Answering System is handling a call, you cannot program. Try again later.</li> </ul>
<p>While programming or searching, the handset starts to ring and the program/search stops.</p>	<ul style="list-style-type: none"> <li>● A call is coming in. To answer the call, press <b>[]</b>, <b>[]</b> or <b>[SP-PHONE]</b>. Start again from the beginning after hanging up.</li> </ul>

## Useful Information

Problem	Cause & Remedy
You cannot make an intercom/outside call.	<ul style="list-style-type: none"> <li>● Your handset is in remote operation mode (page 49). Exit by pressing <b>[OFF]</b>.</li> <li>● The handset you called is too far from the base unit.</li> <li>● If the handset or base unit is in use, you may not be able to make a call. Try again later.</li> <li>● If you are entering a phone number, or the handset enters the caller list, phonebook, redial list or one-touch dialer while the Talking Keypad or Announcement is turned on, you will not be able to make a call using the base unit. To make a call, return to the standby mode.</li> </ul>
You cannot redial.	<ul style="list-style-type: none"> <li>● If the last number dialed was more than 48 digits long, the number will not be redialed correctly.</li> </ul>
You cannot make long distance calls.	<ul style="list-style-type: none"> <li>● Please make sure you have long distance service.</li> </ul>
The handset does not display the caller's name and/or phone number.	<ul style="list-style-type: none"> <li>● You need to subscribe to Caller ID.</li> <li>● Other telephone equipment may be interfering with your phone. Disconnect it and try again.</li> <li>● Other electrical appliances connected to the same outlet may be interfering with Caller ID.</li> <li>● Telephone line noise may be affecting Caller ID.</li> <li>● The caller requested not to send his/her Caller ID information (page 27).</li> <li>● If a call is being transferred to you, the Caller ID information will not be displayed.</li> <li>● If a (separate) Caller ID box is connected between the unit and the telephone wall jack, disconnect the Caller ID box or plug the unit directly into the wall jack.</li> <li>● If your unit is connected to a telephone line with DSL service, we recommend connecting a noise filter between the base unit and the telephone line jack. Contact your DSL provider for details.</li> </ul>
The handset and/or base unit does not announce the displayed caller's name.	<ul style="list-style-type: none"> <li>● The handset and/or base unit ringer volumes are turned off. Set to high, medium, or low (page 39).</li> <li>● The Talking Caller ID feature is turned off. Turn it on (page 41).</li> </ul>
The handset and/or base unit does not announce the displayed caller's name properly.	<ul style="list-style-type: none"> <li>● Name pronunciation may vary. Name pronunciation quality is based on names most commonly used in the United States.</li> <li>● The handset and/or base unit will announce each letter of abbreviations, such as "Co." and "Inc."</li> <li>● Caller ID supports names of up to 15 letters. If the caller's name has more than 15 letters, the name will not be announced correctly.</li> </ul>

<b>Problem</b>	<b>Cause &amp; Remedy</b>
The handset cannot automatically edit the caller list/incoming phone numbers.	<ul style="list-style-type: none"> <li>● The Caller ID number auto edit feature is turned off. Turn it on (page 42) and try again.</li> <li>● You need to press <b>[↶]</b> or <b>[↷]</b> after editing the number.</li> </ul>
The handset display exits the caller list or phonebook.	<ul style="list-style-type: none"> <li>● Do not pause for over 60 seconds while searching.</li> </ul>
The Ringer/Message Alert indicator flashes slowly when the handset is not ringing and in use.	<ul style="list-style-type: none"> <li>● The Message Alert is turned on and new messages have been recorded. Turn the Message Alert off (page 55) or listen to the new messages (page 48, 49, 52).</li> </ul>
You cannot have a conversation using the headset.	<ul style="list-style-type: none"> <li>● Make sure the optional headset is connected properly (page 59).</li> <li>● If <b>"SP-phone"</b> is displayed on the handset, press <b>[↶]</b> to switch to the headset.</li> </ul>
The handset does not announce the name and phone number in the caller list, phonebook, redial list or one-touch dialer.	<ul style="list-style-type: none"> <li>● Name Announcement is turned off. Turn it on (page 44).</li> </ul>
When Talking Keypad is turned on, the phone number you dialed is not announced correctly.	<ul style="list-style-type: none"> <li>● If you dial a phone number quickly, the handset and base unit may not announce the dialed phone number correctly. For best results, dial each digit one at a time, and wait for the unit to announce each digit before dialing the next digit.</li> </ul>
The handset does not announce the entered number when pre-dialing (page 16).	<ul style="list-style-type: none"> <li>● Handset Talking Keypad is turned off. Turn it on (page 44).</li> </ul>
The base unit does not announce the dialed number.	<ul style="list-style-type: none"> <li>● Base Unit Talking Keypad is turned off. Turn it on (page 44).</li> </ul>
When Talking Keypad and/or Name Announcement is turned on, the handset and/or base unit does not make announcements.	<ul style="list-style-type: none"> <li>● The Answering System is in use, such answering a call or playing back messages. Try again later.</li> <li>● The handset has lost communication with the base unit. Walk closer to the base unit and try again.</li> <li>● The base unit is making an outside call.</li> </ul>

## Useful Information

Problem	Cause & Remedy
<p>When Name Announcement is turned on, the handset does not announce names properly.</p>	<ul style="list-style-type: none"><li>● If the name has more than 10 syllables, it will not be announced correctly. Maximum syllables that can be announced is 10. One digit of the number is counted as one syllable.</li><li>● If the name has been abbreviated or an acronym is used, it may not be announced correctly. We recommend inserting a space between each letter (page 22).</li></ul>
<p>While the handset is announcing name or phone numbers, static, sound cuts in/out or fades occur.</p>	<ul style="list-style-type: none"><li>● Announcement is transmitted between the base unit and handset using wireless radio waves. Move the handset and base unit away from other electrical appliances to prevent interference (page 7).</li></ul>
<p>The talk time on the handset has been shortened.</p>	<ul style="list-style-type: none"><li>● Fully charge the battery (page 9).</li><li>● The battery may need to be replaced. If you install a new battery, fully charge it (page 9).</li><li>● The Hearing Aid mode is selected to “Telecoil”. Turn it off (page 44) and try again.</li></ul>



## Answering System

Problem	Cause & Remedy
The Answering System is on, but incoming messages are not recorded.	<ul style="list-style-type: none"> <li>● The recording time is set to “Greeting only”. Select “1 minute”, “2 minutes” or “3 minutes” (page 54).</li> <li>● Memory is full. Erase unnecessary messages (page 49)</li> </ul>
“ <b>FULL</b> ” flashes and the ANSWER ON indicator flashes rapidly. No new messages are recorded.	<ul style="list-style-type: none"> <li>● Memory is full. Erase unnecessary messages (page 49).</li> </ul>
You cannot operate the Answering System from the base unit or the handset.	<ul style="list-style-type: none"> <li>● If another user is in use, you may not be able to operate the Answering System. Try again later.</li> <li>● If another user is listening to messages or the Answering System is handling a call, you cannot operate the Answering System. Try again later.</li> <li>● When the unit is announcing a list item (name or phone number) or a dialed number, you cannot operate the Answering System. Try again later.</li> </ul>
You cannot operate the Answering System from a touch tone phone.	<ul style="list-style-type: none"> <li>● Make sure you entered the correct remote code (page 54).</li> <li>● The Answering System may not respond if the tones are too short to activate the unit. Press each button firmly.</li> <li>● The Answering System is off. Turn it on (page 47).</li> </ul>
You cannot erase messages.	<ul style="list-style-type: none"> <li>● While another user is operating the Answering System or a caller is leaving a message, you cannot erase messages.</li> </ul>
When you play back messages or turn on the Answering System, the handset and base unit announce the wrong day and time.	<ul style="list-style-type: none"> <li>● The date and time may be set incorrectly. Set the date and time again (page 15).</li> </ul>

### General

Problem	Cause & Remedy
The unit does not work.	<ul style="list-style-type: none"><li>● Check the settings (page 8).</li><li>● Check whether the dialing mode setting is correct (page 15).</li><li>● Fully charge the battery (page 9).</li><li>● Clean the charge contacts and charge again (page 10).</li><li>● Check battery installation (page 9).</li><li>● Unplug the base unit's AC adaptor to reset it. Plug in, and try again.</li><li>● Re-install the battery (page 9) and fully charge it.</li></ul>
"Recharge battery" is displayed, "■" flashes, or the handset beeps intermittently.	<ul style="list-style-type: none"><li>● Fully charge the battery (page 9).</li></ul>
"Charge for 6h" and "■" are displayed and the handset does not work.	<ul style="list-style-type: none"><li>● The battery has been discharged. Fully charge the battery (page 9).</li><li>● Check battery installation (page 9).</li></ul>
You charged the battery fully, but "Recharge battery" is still displayed and/or "■" continues to flash, or "Charge for 6h" and "■" are displayed.	<ul style="list-style-type: none"><li>● Clean the charge contacts and charge again (page 10).</li><li>● The battery may need to be replaced. If you install a new battery, fully charge it (page 9).</li></ul>
The CHARGE indicator does not go out after the battery has been charged.	<ul style="list-style-type: none"><li>● This is normal.</li></ul>
If you cannot solve your problem	<ul style="list-style-type: none"><li>● Visit our website: <a href="http://www.panasonic.com/support">http://www.panasonic.com/support</a></li><li>● Contact us via the web at: <a href="http://www.panasonic.com/contactinfo">http://www.panasonic.com/contactinfo</a></li><li>● Call our customer call center at: 1-800-211-PANA(7262)</li></ul>

## FCC and other information

This equipment complies with Part 68 of the FCC rules and the requirements adopted by the ACTA. On the bottom of this equipment is a label that contains, among other information, a product identifier in the format US:ACJ-----.

If requested, this number must be provided to the telephone company.

- Registration No  
.....(found on the bottom of the unit)
- Ringer Equivalence No.  
(REN).....0.1B

A plug and jack used to connect this equipment to the premises wiring and telephone network must comply with the applicable FCC Part 68 rules and requirements adopted by the ACTA. A compliant telephone cord and modular plug is provided with the product. It is designed to be connected to a compatible modular jack that is also compliant.

The REN is used to determine the number of devices that may be connected to a telephone line. Excessive RENs on a telephone line may result in the devices not ringing in response to an incoming call. In most but not all areas, the sum of RENs should not exceed five (5.0). To be certain of the number of devices that may be connected to a line, as determined by the total RENs, contact the local telephone company. For products approved after July 23, 2001, the REN for the product is part of the product identifier that has the format US:AAAEQ##TXXXX. The digits represented by ## are the REN without a decimal point (e.g., 03 is a REN of 0.3).

If this equipment causes harm to the telephone network, the telephone company will notify you in advance that temporary discontinuance of service may be required. But if advance notice isn't practical, the telephone company will

notify the customer as soon as possible. Also, you will be advised of your right to file a complaint with the FCC if you believe it is necessary.

The telephone company may make changes in its facilities, equipment, operations or procedures that could affect the operation of the equipment. If this happens the telephone company will provide advance notice in order for you to make necessary modifications to maintain uninterrupted service.

If trouble is experienced with this equipment, for repair or warranty information, please contact a Factory Servicenter or other Authorized Servicer. If the equipment is causing harm to the telephone network, the telephone company may request that you disconnect the equipment until the problem is resolved.

Connection to party line service is subject to state tariffs. Contact the state public utility commission, public service commission or corporation commission for information.

If your home has specially wired alarm equipment connected to the telephone line, ensure the installation of this equipment does not disable your alarm equipment. If you have questions about what will disable alarm equipment, consult your telephone company or a qualified installer.

- This product is a bone conduction telephone product, which does not use a conventional acoustic speaker, and as such is non-hearing aid compatible as defined by the FCC in 47CFR, Section 68.316.
- This product may not be used in any public location.
- Bone Conduction may benefit people with conductive and/or mixed hearing losses and elderly people who are experiencing difficulty in hearing.

## Useful Information

---

When you hold the phone to your ear, noise might be heard in your Hearing Aid. Some Hearing Aids are not adequately shielded from external RF (radio frequency) energy. If noise occurs, turn the Hearing Aid mode to Telecoil. If noise is still heard, use an optional accessory headset or the speakerphone option (if applicable) when using this phone. Consult your audiologist or Hearing Aid manufacturer about the availability of Hearing Aids which provide adequate shielding to RF energy commonly emitted by digital devices.

### WHEN PROGRAMMING EMERGENCY NUMBERS AND/OR MAKING TEST CALLS TO EMERGENCY NUMBERS:

- 1) Remain on the line and briefly explain to the dispatcher the reason for the call.
- 2) Perform such activities in the off-peak hours, such as early morning or late evenings.

This device complies with Part 15 of the FCC Rules. Operation is subject to the following two conditions:

(1) This device may not cause harmful interference, and (2) this device must accept any interference received, including interference that may cause undesired operation.

Privacy of communications may not be ensured when using this phone.

### CAUTION:

Any changes or modifications not expressly approved by the party responsible for compliance could void the user's authority to operate this device.

### NOTE:

This equipment has been tested and found to comply with the limits for a Class B digital device, pursuant to Part 15 of the FCC Rules. These limits are designed to provide reasonable protection against harmful interference in a residential installation. This equipment generates, uses, and can radiate radio frequency energy and, if not installed and used in accordance with the instructions, may cause harmful interference to radio communications. However, there is no guarantee that interference will not occur in a particular installation. If this equipment does cause harmful interference to radio or television reception, which can be determined by turning the equipment off and on, the user is encouraged to try to correct the interference by one or more of the following measures:

- Reorient or relocate the receiving antenna.
- Increase the separation between the equipment and receiver.
- Connect the equipment into an outlet on a circuit different from that to which the receiver is connected.
- Consult the dealer or an experienced radio/TV technician for help.

Some cordless telephones operate at frequencies that may cause interference to nearby TVs and VCRs. To minimize or prevent such interference, the base of the cordless telephone should not be placed near or on top of a TV or VCR. If interference is experienced, move the cordless telephone further away from the TV or VCR. This will often reduce, or eliminate, interference.

**FCC RF Exposure Warning:**

The product complies with FCC radiation exposure limits set forth for an uncontrolled environment. To comply with FCC RF exposure requirements the base unit must be installed and operated with its antenna located 20 cm or more between antenna and all person's body (excluding extremities of hands, wrist and feet). The handset may be carried and operated with only the specific provided belt-clip. Other non-tested belt-clips or similar body-worn accessories may not comply and must be avoided. The base and handset units must not be colocated or operated in conjunction with any other antenna or transmitter.

---

### Specifications

---

#### Base unit

**Operating environment:**

5 °C – 40 °C (41 °F – 104 °F)

**Frequency:**

2.4 GHz – 2.48 GHz

**Dimensions:**

Approx. height 85 mm x width 175 mm x depth 200 mm (3 <sup>11</sup>/<sub>32</sub>" x 6 <sup>7</sup>/<sub>8</sub>" x 7 <sup>7</sup>/<sub>8</sub>"

**Mass (Weight):**

Approx. 470 g (1.04 lb.)

**Power consumption:**

Standby: Approx. 2.0 W

Maximum: Approx. 5.4 W

**Power supply:**

AC adaptor (120 V AC, 60 Hz)

**TX power:**

125 mW (max.)

---

#### Handset

**Operating environment:**

5 °C – 40 °C (41 °F – 104 °F)

**Frequency:**

2.4 GHz – 2.48 GHz

**Dimensions:**

Approx. height 208 mm x width 52 mm x depth 49 mm (8 <sup>3</sup>/<sub>16</sub>" x 2 <sup>1</sup>/<sub>16</sub>" x 1 <sup>15</sup>/<sub>16</sub>"

**Mass (Weight):**

Approx. 195 g (0.43 lb.)

**Power supply:**

Ni-MH battery (3.6 V, 830 mAh)

**TX power:**

125 mW (max.)

**Security codes:**

1,000,000

---

#### Charger unit

**Operating environment:**

5 °C – 40 °C (41 °F – 104 °F)

**Dimensions:**

Approx. height 69 mm x width 74 mm x depth 99 mm (2 <sup>23</sup>/<sub>32</sub>" x 2 <sup>29</sup>/<sub>32</sub>" x 3 <sup>29</sup>/<sub>32</sub>"

**Mass (Weight):**

Approx. 110 g (0.24 lb.)

**Power consumption:**

Standby: Approx. 0.8 W

Maximum: Approx. 4.0 W

**Power supply:**

AC adaptor (120 V AC, 60 Hz)

**Note:**

- Design and specifications are subject to change without notice.
- The illustrations in these instructions may vary slightly from the actual product.

**Energy Star:**

As an ENERGY STAR® Participant, Panasonic has determined that this product meets the ENERGY STAR guidelines for energy efficiency. ENERGY STAR is a U.S. registered mark.



## Warranty

PANASONIC CONSUMER  
ELECTRONICS COMPANY, DIVISION  
OF PANASONIC CORPORATION OF  
NORTH AMERICA  
One Panasonic Way,  
Secaucus, New Jersey 07094

PANASONIC PUERTO RICO, INC.  
San Gabriel Industrial Park,  
Ave. 65 de Infantería, Km. 9.5,  
Carolina, Puerto Rico 00985

## Panasonic Telephone Products Limited Warranty

### Limited Warranty Coverage

If your product does not work properly because of a defect in materials or workmanship, Panasonic Consumer Electronics Company or Panasonic Puerto Rico, Inc. (collectively referred to as "the warrantor") will, for the length of the period indicated on the chart below, which starts with the date of original purchase ("Limited Warranty period"), at its option either (a) repair your product with new or refurbished parts, or (b) replace it with a new or a refurbished product. The decision to repair or replace will be made by the warrantor.

Parts	Labor
One (1) Year	One (1) Year

During the "Labor" Limited Warranty period there will be no charge for labor. During the "Parts" Limited Warranty period, there will be no charge for parts. You must mail-in your product during the Limited Warranty period. This Limited Warranty excludes both parts and labor for batteries, antennas, and cosmetic parts (cabinet). This Limited Warranty only applies to products purchased and serviced in the United States or Puerto Rico. This Limited Warranty is extended only to the original purchaser and only covers products purchased as new.

### Mail-In Service

For assistance in the continental U.S.A. in obtaining repairs please ship the product to:

#### **Panasonic Services Company Customer Servicenter**

**4900 George McVay Drive Suite B Door #12 McAllen, TX 78503**

For assistance in Puerto Rico call Panasonic Puerto Rico, Inc. (787)-750-4300 or fax (787)-768-2910.

For Limited Warranty service for headsets if a headset is included with this product please call Panasonic Call Center at 1-800-211-PANA (7262).

When shipping the unit carefully pack, include all accessories, and send it prepaid, adequately insured and preferably in the original carton. Include a letter detailing the complaint and provide a day time phone number where you can be reached.

**IF REPAIR IS NEEDED DURING THE LIMITED WARRANTY PERIOD THE PURCHASER WILL BE REQUIRED TO FURNISH A SALES RECEIPT/PROOF OF PURCHASE INDICATING DATE OF PURCHASE, AMOUNT PAID AND PLACE OF PURCHASE. CUSTOMER WILL BE CHARGED FOR THE REPAIR OF ANY UNIT RECEIVED WITHOUT SUCH PROOF OF PURCHASE.**

### Limited Warranty Limits And Exclusions

This Limited Warranty ONLY COVERS failures due to defects in materials or workmanship, and DOES NOT COVER normal wear and tear or cosmetic damage. The Limited Warranty ALSO DOES NOT COVER damages which occurred in shipment, or failures which are caused by products not supplied by the warrantor, or failures which result from accidents, misuse, abuse, neglect, mishandling, misapplication, alteration, faulty installation, set-up adjustments, misadjustment of consumer controls, improper maintenance, power line surge, lightning damage, modification, introduction of sand, humidity or liquids, commercial use such as hotel, office, restaurant, or other business or rental use of the product, or service by anyone other than a Factory Servicenter or other Authorized Servicer, or damage that is attributable to acts of God.

**THERE ARE NO EXPRESS WARRANTIES EXCEPT AS LISTED UNDER "LIMITED WARRANTY COVERAGE". THE WARRANTOR IS NOT LIABLE FOR INCIDENTAL OR CONSEQUENTIAL DAMAGES RESULTING FROM THE USE OF THIS PRODUCT, OR ARISING OUT OF ANY BREACH OF THIS LIMITED WARRANTY.** (As examples, this excludes damages for lost time, lost calls or messages, cost of having someone remove or re-install an installed unit if applicable, travel to and from the servicer. The items listed are not exclusive, but are for illustration only.) **ALL EXPRESS AND IMPLIED WARRANTIES, INCLUDING THE WARRANTY OF MERCHANTABILITY, ARE LIMITED TO THE PERIOD OF THE LIMITED WARRANTY.**

Some states do not allow the exclusion or limitation of incidental or consequential damages, or limitations on how long an implied warranty lasts, so the exclusions may not apply to you.

This Limited Warranty gives you specific legal rights and you may also have other rights which vary from state to state. If a problem with this product develops during or after the Limited Warranty period, you may contact your dealer or Servicenter. If the problem is not handled to your satisfaction, then write to the warrantor's Consumer Affairs Department at the addresses listed for the warrantor.

**PARTS AND SERVICE, WHICH ARE NOT COVERED BY THIS LIMITED WARRANTY, ARE YOUR RESPONSIBILITY.**



## Customer services

### **Customer Services Directory**

Obtain Product Information and Operating Assistance; locate your nearest Dealer or Servicenter; purchase Parts and Accessories; or make Customer Service and Literature requests by visiting our Web Site at:

**<http://www.panasonic.com/consumersupport>**

or, contact us via the web at:

**<http://www.panasonic.com/contactinfo>**

You may also contact us directly at: 1-800-211-PANA (7262),  
Monday-Friday 9 am-9 pm; Saturday-Sunday 10 am-7 pm, EST.

TTY users (hearing or speech impaired users) can call 1-877-833-8855.

### **Accessory Purchases**

Purchase Parts, Accessories and Instruction Books online for all Panasonic Products by visiting our Web Site at:

**<http://www.pasc.panasonic.com>**

or, send your request by E-mail to:

**[npcparts@us.panasonic.com](mailto:npcparts@us.panasonic.com)**

You may also contact us directly at:

1-800-332-5368 (Phone) 1-800-237-9080 (Fax Only)

(Monday - Friday 9 am to 8 pm, EST.)

Panasonic Services Company

20421 84th Avenue South, Kent, WA 98032

(We Accept Visa, MasterCard, Discover Card, American Express, and Personal Checks)

TTY users (hearing or speech impaired users) can call 1-866-605-1277.

### **Service in Puerto Rico**

Panasonic Puerto Rico, Inc.

San Gabriel Industrial Park, Ave. 65 de Infantería, Km. 9.5,

Carolina, Puerto Rico 00985

Phone (787)750-4300, Fax (787)768-2910

## Index

- A**
  - Accessories: 4
  - Answering calls, base unit: 20
  - Answering calls, handset: 20
  - Answering system: 46
  - Auto talk: 20, 43
- B**
  - Backlit display: 14
  - Backlit handset keypad: 14
  - Battery
    - Charge: 9
    - Installation: 9
    - Performance: 10
    - Replacement: 11
    - Strength: 10
  - Belt clip: 58
  - Bone conduction earpiece: 11, 13
- C**
  - Call screening: 48
  - Call share: 34
  - Call Waiting Caller ID: 27
  - Call Waiting Caller ID display: 21
  - Call waiting tone: 21
  - Caller ID edit: 42
  - Caller ID number auto edit: 30
  - Caller ID service: 15, 27
  - Caller list
    - Editing: 30
    - Erasing: 31
    - Storing: 31
    - Viewing: 28
  - Chain dial: 24
  - Charger unit: 8
  - Conference calls: 34
  - Connections
    - AC adaptor: 8
    - Charger unit: 8
    - Telephone line cord: 8
  - Controls
    - Base unit: 12
    - Charger unit: 13
    - Handset: 13
- D**
  - Date and time: 15
  - Dialing mode: 15
  - Display
    - Base unit: 14
    - Display language: 14
- E**
  - Erasing a message: 49, 51, 53
  - Erasing all messages: 49, 51, 53
  - Error messages: 60
- F**
  - FCC and other information: 67
  - FLASH button: 21
  - FLASH time: 43
  - Function menu
    - Direct commands: 37
    - Table: 35
- G**
  - Greeting message: 46
- H**
  - Headset, optional: 59
  - Hearing Aid: 44
  - Hold: 18, 19
- I**
  - Incoming call tone
    - base unit: 40
    - handset: 40
  - Installation, AC adaptor: 8
  - Installation, telephone line cord: 8
  - Intercom
    - Call: 32
    - Paging: 32
- K**
  - Key tone: 42
- L**
  - LCD contrast, handset: 41
  - Line mode: 43
  - Listening to messages
    - Base unit: 48
    - Handset: 49
    - Touch tone phone: 52
- M**
  - Making calls, base unit: 18
  - Making calls, handset: 16
  - Memo message: 51
  - Memory capacity: 52
  - Message alert: 55
  - Microphone, base unit: 18
  - Microphone, handset: 16
  - Mute: 20
- N**
  - Name Announcement: 44
  - Navigator key: 13

- Noise: 7  
Number of rings: 54
- O**  
One-Touch Dialer  
Dialing: 25  
Erasing: 26  
Storing: 25
- P**  
PAUSE: 17  
Pause: 17  
Phonebook  
Adding: 22  
Calling: 23  
Erasing: 24  
Names: 22  
Power failure: 8, 15  
Pre-dial: 16  
Pulse service: 21
- R**  
Recording mode: 55  
Recording time: 54  
Redial: 17, 19  
Redial list: 17  
Registration: 45  
Remote code: 54  
Remote operation: 52  
Ringer off  
Base unit: 39  
Handset: 20  
Ringer tone  
Base unit: 40  
Handset: 39  
Ringer volume  
Base unit: 39  
Handset: 39  
Rotary service, tone dialing: 21
- S**  
Safety instructions: 5  
Shoulder rest attachment: 59  
Slow Talk message playback: 49, 50, 51, 53  
Soft keys: 14  
Specifications: 70  
SP-phone, base unit: 18  
SP-phone, handset: 16
- T**  
Talking Caller ID  
Base unit: 41  
Handset: 41
- Talking Keypad, base unit: 44  
Talking Keypad, handset: 44  
Toll saver: 55  
Transferring a call: 33  
Troubleshooting, Answering System: 65  
Troubleshooting, general: 66  
TTY: 4, 73
- V**  
Voice guidance: 50, 53  
Volume control, base unit: 19, 49  
Volume control, handset: 17
- W**  
Wall mounting, base unit: 56  
Wall mounting, charger unit: 58  
Warranty: 71

## ***If you need assistance with setup or operation;***

- 1** Visit our website: <http://www.panasonic.com/consumersupport>
- 2** Contact us via the web at: <http://www.panasonic.com/contactinfo>
- 3** Call us at: 1-800-211-PANA (7262)  
TTY users (hearing or speech impaired users) can call 1-877-833-8855.

## **When you ship the product;**

- Carefully pack your unit, preferably in the original carton.
- Attach a letter, detailing the symptom, to the outside of the carton.
- Send the unit to Panasonic Services Company Customer Servicenter, prepaid and adequately insured.
- Do not send your unit to Panasonic Consumer Electronics Company listed below or to executive or regional sales offices. These locations do not repair consumer products.

- |   |
|---|
| <ul style="list-style-type: none"><li>• This cordless telephone is designed for use in the United States of America. Sale or use of this product in other countries may violate local laws.</li><li>• Ce téléphone sans fil est conçu pour être utilisé aux États-Unis d'Amérique. La vente ou l'emploi de cet appareil dans certains autres pays peut constituer une infraction à la législation locale.</li><li>• Este teléfono inalámbrico fue elaborado para uso en los Estados Unidos de América. La venta o el empleo de este producto en ciertos países puede constituir violación de la legislación local.</li><li>• このコードレス電話機は、日本国外での使用を目的として設計されており、日本国内での使用は法律違反となります。従って、当社では日本国内においては原則として修理などのサービスは致しかねます。</li></ul> |
|---|

### **Copyright:**

This material is copyrighted by Panasonic Communications Co., Ltd., and may be reproduced for internal use only. All other reproduction, in whole or in part, is prohibited without the written consent of Panasonic Communications Co., Ltd.

© 2005 Panasonic Communications Co., Ltd. All Rights Reserved.

**Panasonic Consumer Electronics Company,  
Division of Panasonic Corporation of North America**  
One Panasonic Way, Secaucus, New Jersey 07094

**Panasonic Puerto Rico, Inc.**  
San Gabriel Industrial Park, Ave. 65 de Infantería, Km. 9.5,  
Carolina, Puerto Rico 00985